

CITY OF EVANSTON

SPECIFICATIONS AND BID DOCUMENTS
Construction Bid with Sub-contractors

BID NUMBER: 23-22

For

Robert Crown Community Center
Gymnasium Acoustic Panel Installation
March 9, 2023



BID DUE DATE: 2:00 P.M., Tuesday, April 4, 2023

VIRTUAL BID OPENING: 2:15 P.M., Tuesday, April 4, 2023
Google Meet ID: meet.google.com/erk-vjyw-pza
Phone Number: 617-675-4444
PIN: 491 020 418 0044#

BID BOND: 5% of Contract Amount

**PERFORMANCE/MATERIAL
& LABOR PAYMENT BOND:** 100% of Contract Amount

CONTRACT PERIOD: Substantial Completion: June 30, 2023
Final Completion: July 28, 2023

ELECTRONIC BID SUBMITTAL:

Bid responses will only be accepted electronically
via E-bidding through DemandStar (WWW.DEMANDSTAR.COM)
**It is highly recommended that new DemandStar users complete the account
setup process prior to project due date/time.**

TABLE OF CONTENTS

SPECIFICATION SECTION	NUMBER OF PAGES
-----------------------	-----------------

DIVISION 0 – BIDDING REQUIREMENTS

Notice to Bidders	1
Instructions to Bidders/Requirements for Bidding	11
General Conditions	11
Insurance Requirements	1

RETURN ALL EXHIBITS WITH THE BID

Exhibit A Bid Form	8
Exhibit B City of Evanston M/W/EBE Policy	1
Exhibit C M/W/EBE Participation Compliance Form	1
Exhibit D M/W/EBE Participation Waiver Request	1
Exhibit E Construction Contractors' Assistance Organizations	1
*Exhibit F Local Employment Program Compliance	2
Exhibit G Certification of Bidder Regarding Equal Employment Opportunity	1
Exhibit H Disclosure of Ownership Interests	4
Exhibit I Additional Information Sheet	1
Exhibit J Certification of Compliance with Prevailing Wage Rate Act	1
Exhibit K Major Sub-contractors Listing	1
Exhibit L Conflict of Interest	1
Exhibit M Signature Form	1
Exhibit N Contractor Services Agreement Acknowledgement	1
Exhibit N Contractor Services Agreement	23
Exhibit O BID Bond Submittal Label	1

DIVISION 1 – General Requirements

Section 010000 Project Requirements	2
Section 010100 Summary of Work	3
Section 010270 Applications for Payment	3
Section 012100 Allowances	2
Section 015600 Temporary Environmental Controls	2
Section 016000 Materials and Equipment	5
Section 017100 Cleaning	3

ATTACHMENTS

Scope of Work	9
Prevailing Wages	7
DemandStar E-bidding Information	14

***NOTE: THE SELECTED BIDDER WILL BE SUBJECT TO THE REGULATIONS CONTAINED IN CITY OF EVANSTON ORDINANCE 60-O-14 AMENDMENTS TO THE LOCAL EMPLOYMENT PROGRAM (LEP)**

**CITY OF EVANSTON
NOTICE TO BIDDERS**

Bids will be received by the City's Purchasing Office until 2:00 P.M. local time Tuesday, April 4, 2023 and will be publically read virtually via Google Meets at 2:15 P.M. Interested parties can use the following link: meet.google.com/erk-vjyw-pza or join by phone at 617-675-4444, PIN: 491 020 418 0044# to access the virtual bid opening. The City of Evanston no longer accepts hard copy paper submittals for any solicitation. Responses will only be accepted electronically via E-bidding through DemandStar (www.demandstar.com). Although registration is required, vendors can download solicitations and upload responses for free. Bids shall cover the following:

**Robert Crown Community Center
Gymnasium Acoustic Panel Installation
Bid Number: 23-22**

Work on this project includes installation of Owner provided acoustic panels in the gymnasium of the Robert Crown Community Center located at 1801 Main Street in Evanston, Illinois.

The above item shall conform to the Invitation for Bids on file in the Purchasing Office. Parties interested in submitting a bid should contact the Purchasing Office to receive a copy of the bid or see the City's website at: www.cityofevanston.org/business/bids-proposals/ or DemandStar at: www.demandstar.com.

The City of Evanston (the City) in accordance with the laws of the State of Illinois, hereby notifies all Bidders that it will affirmatively ensure that the contract(s) entered into pursuant to this Notice will be awarded to the successful Bidders without discrimination on the ground of race, color, religion, sex, age, sexual orientation, marital status, disability, familial status or national origin. The State of Illinois requires under Public Works contracts that the general prevailing rate of wages in this locality be paid for each craft or type of worker hereunder. This requirement is in accordance with The Prevailing Wage Act (820 ILCS 130) as amended. The City of Evanston reserves the right to reject any or all submittals or to accept the submittal(s) deemed most advantageous to the City.

The Evanston City Council also reserves the right to award the contract to an Evanston firm if that firm's bid is within 5% of the low bid.

Each Bidder shall be required to submit with their bid a disclosure of ownership interest statement form in accordance with the provisions of City Code Section 1-18-1 *et seq.* Failure to submit such information will result in the disqualification of such bid.

Linda Thomas
Purchasing Specialist

INSTRUCTIONS TO BIDDERS/REQUIREMENTS FOR BIDDING (CONTRACTS OVER \$25,000)

1. ON-LINE NOTIFICATION OF SOLICITATIONS

The City is utilizing Demandstar.com (www.demandstar.com) for on-line notification purposes only for sealed bids when it is anticipated that the amount of the resulting contract will be in excess of its formal bid limit of \$25,000, such as this requirement. Interested Bidders are required to submit a sealed bid to the City by the date/time indicated for this requirement on the forms provided by the City.

2. SUBMISSION OF BIDS

- A. The City of Evanston no longer accepts hard copy paper submittals for any solicitation. Responses will only be accepted electronically via E-bidding through DemandStar (WWW.DEMANDSTAR.COM). Although registration is required, vendors can download solicitations and upload bid responses for free. **Please refer to attached DemandStar E-bidding documents.**
- B. ANY BIDS RECEIVED AFTER THE TIME AND DATE SPECIFIED FOR THE RECEIPT OF BIDS WILL NOT BE ACCEPTED. It is the sole responsibility of the Bidder to insure that his or her bid is delivered by the stated bid opening time. THE CITY IS NOT RESPONSIBLE FOR INCOMPLETE UPLOADED SUBMITTALS.
- C. Bids will be opened on the date and time stated.
- D. Any Bidder may withdraw his or her bid by letter or with proper identification by personally securing his or her bid at any time prior to the stated bid opening time. No telephone request for withdrawal of bids will be honored.

3. PREPARATION OF BIDS

The Bidder must prepare the bid on the attached bid forms. Unless otherwise stated, all blank spaces on the bid form or pages must be filled in. Either a unit price, lump sum price, or a "no-bid", as the case may be, must be stated for each and every item and must be either typed in or written in ink.

4. SIGNING OF BIDS

- A. Bids which are signed for a partnership should be signed in the firm's name by all partners or in the firm's name by Attorney-in-Fact. If signed by Attorney-in-Fact, there should be attached to the bid a Power of Attorney evidencing authority to sign the bid, dated the same date as the bid and executed by all partners of the firm.
- B. Bids which are signed for a corporation should have the correct corporate name thereon and signature of an authorized officer of the corporation manually written below the corporate name following words "By: " _____ " title of office held by the person signing for corporation, which shall appear below signature of an officer.

- C. Bids which are signed by an individual doing business under a fictitious name should be signed in the name of the individual "doing business as. _____."
- D. The name of each person signing the bid shall be typed or printed below his or her signature.

5. CONSIDERATION OF BIDS

The Purchasing Specialist shall represent and act for the City in all matters pertaining to this bid and the contract in conjunction therewith.

6. WITHDRAWAL OF BIDS

Bidders may withdraw or cancel their bids at any time prior to the advertised bid opening time. After the bid opening time, no bid shall be withdrawn or canceled for a period of sixty (60) calendar days. When contract approval is required by another agency, such as the Federal Government or the State of Illinois, no bid shall be withdrawn or canceled for a period of ninety (90) calendar days.

7. ERRORS IN BIDS

Bidders are cautioned to verify their bids before submission. Negligence on the part of the respondent in preparing the bid confers no right for withdrawal or modification of the bid after it has been opened. In case of error in the extension of prices in the bid, unit prices will govern.

8. ADDENDA

- A. Any and all changes to the specifications/plans are valid only if they are included by written addendum to all Bidders. Each Bidder must acknowledge receipt of any addenda by indicating on the Bid form. Each Bidder, by acknowledging receipt of any addenda, is responsible for the contents of the addenda and any changes to the bid therein. Failure to acknowledge any addenda may cause the bid to be rejected.
- B. Addenda information is available over the internet at: [City of Evanston Notices to Bidders](#) or www.demandstar.com, or by contacting the Purchasing Office.

9. RESERVED RIGHTS

The City of Evanston reserves the right at any time and for any reason to cancel his or her solicitation, to accept or reject any or all bids or any portion thereof, or to accept an alternate response. The City reserves the right to waive any immaterial defect in any response. The City may seek clarification from any respondent at any time, and failure to respond within a reasonable time period, or as otherwise directed, will be cause for rejection.

10. AWARD

It is the intent of the City to award a contract to the lowest responsible Bidder meeting specifications. The City reserves the right to determine the lowest

responsible Bidder on the basis of an individual item, groups of items, or in any way determined to be in the best interest of the City. Award will be based on the following factors (where applicable): (a) adherence to all conditions and requirements of the bid specifications; (b) price; (c) qualifications of the Bidder, including past performance, financial responsibility, general reputation, experience, service capabilities, and facilities; (d) delivery or completion date; (e) product appearance, workmanship, finish, taste, feel, overall quality, and results of product testing; (f) maintenance costs and warranty provisions; and (g) repurchase or residual value.

11. INTERPRETATION OR CORRECTION OF BIDDING DOCUMENTS

Bidder's shall promptly notify the City of any ambiguity, inconsistency, or error that they discover upon examination of the bidding documents. Interpretations, corrections, and changes will be made by addendum. Each Bidder shall ascertain prior to submitting a bid that all addenda have been received and are acknowledged in the bid.

12. INCONSISTENCIES AND OMISSIONS

These specifications and the accompanying plans, if any, are intended to include all information necessary for the work contemplated. If, by inadvertence or otherwise, the plans or specifications omit some information necessary for that purpose, the contractor shall, nevertheless, be required to perform such work at no additional cost to the City so that the project may be completed according to the true intent and purpose of the plans and specifications.

13. CONDITIONS

Bidders are advised to become familiar with all conditions, instructions, and specifications governing his or her bid. Once the award has been made, failure to have read all the conditions, instructions and specifications of this contract shall not permit the Bidder to amend contract or to request additional compensation.

14. VERIFICATIONS OF DATA

- A. It is understood and agreed that the unit quantities given in these specifications are approximate only, and the contractor shall verify these quantities before bidding as no claim shall be made against the City on, or account of, any excess or deficiency in the same.
- B. The contractor shall have visited the premises and determined for itself, by actual observation, boring, test holes, or other means, the nature of all soil and water conditions (both above and below ground in the line of work) that may be encountered in all construction work under this contract. The cost of all such inspection, borings, etc. shall be borne by the contractor, and no allowance will be made for the failure of the contractor to estimate correctly the difficulties attending the execution of the work.

15. SPECIFICATIONS

Reference to brand names and numbers is meant to be descriptive, not restrictive,

unless otherwise specified. Bids on equivalent items will be considered, provided the Bidder clearly states exactly what is proposed to be furnished, including complete specifications. Unless the Bidder specifies otherwise, it is understood the Bidder is offering a referenced brand item as specified or is bidding as specified when no brand is referenced, and does not propose to furnish an “equal.” The City reserves the right to determine whether a substitute offer is equivalent to, and meets the standard of quality indicated by the brand name and number.

16. SAMPLES

When samples of items are called for by the specifications, samples must be furnished free of expense, and if not destroyed in the evaluation process will be returned at the Bidder’s expense upon request. Request for the return of samples must accompany the sample and must include a UPS/Fed-Ex Pickup Slip, postage, or other acceptable mode of return. Individual samples must be labeled with Bidder’s name, invitation number, item reference, manufacturer’s brand name and number.

17. REGULATORY COMPLIANCE

Each Bidder represents and warrants that the goods or services furnished hereunder (including all labels, packages and containers for said goods) comply with all applicable standards, rules and regulations in effect under the requirements of all Federal, State, and local laws, rules and regulations as applicable, including the Occupational Safety and Health Act as amended, with respect to design, construction, manufacture, or use for their intended purpose of said goods or services. Each Bidder must furnish a “Material Safety Data Sheet” in compliance with the Illinois Toxic Substances Disclosure to Employees Act when required.

18. PRICING

The price quoted for each item is the full purchase price, including delivery to destination, and includes all transportation and handling charges, materials or service costs, patent royalties, and all other overhead charges of every kind and nature. Unless otherwise specified, prices shall remain firm for the contract period.

19. DISCOUNTS

Prices quoted must be net after deducting all trade and quantity discounts. Where cash discounts for prompt payment are offered, the discount period shall begin with the date of receipt of a correct invoice or receipt or final acceptance of goods, whichever is later.

20. INSPECTION

Materials or equipment purchased are subject to inspection and approval at the City’s destination. The City reserves the right to reject and refuse acceptance of items which are not in accordance with the instructions, specifications, drawings or data of Seller’s warranty (express or implied). Rejected materials or equipment shall be removed by, or at the expense of, the Seller promptly after rejection.

21. BIDS AND PLAN DEPOSITS

- A. When required on the cover sheet, all bids shall be accompanied by a bid deposit in the amount specified. Bid deposits shall be in the form of cash, a certified check, or cashier's check drawn on a responsible bank doing business in the United States and shall be made payable to the City of Evanston. Bid Bonds are also acceptable. All bids not accompanied by a bid deposit, when required, will be rejected.
- B. The City will return the bid deposits of all but the 3 lowest qualified Bidders, whose deposit will be held until contract award or at the expiration of the sixty-day or ninety-day period for bid award.
- C. The bid deposit of the successful Bidder will be retained until contract documents have been executed and the Contractor has submitted all the required information. Failure to comply with the terms of this specification may be cause for forfeiture of said deposit.
- D. When required, plan deposits will be refunded should the plans be returned in good condition within 10 days of the bid opening.

22. DISPUTES

Any dispute concerning a question of fact arising under this bid shall be decided by the Purchasing Specialist, who shall issue a written decision to the Bidder. The decision of the Purchasing Specialist shall be final and binding.

23. CATALOGS

Each Bidder shall submit, when requested by the Purchasing Specialist, catalogs, descriptive literature, and detailed drawings, fully detailing features, designs, construction, appointments, finishes and the like not covered in the specifications, necessary to fully describe the material or work proposed to be furnished.

24. TAXES

- A. Federal Excise Tax does not apply to materials purchased by the City of Evanston by virtue of Exemption Certificate No. A-208762, Illinois Retailers' Occupation Tax, Use Tax, and Municipal Retailers' Occupation Tax do not apply to materials or services purchased by the City of Evanston by virtue of Statute.
- B. The City of Evanston is exempt from Illinois Sales Tax by virtue of Exemption Identification number E9998-1750.
- C. The City's federal tax ID number is 36-6005870.

25. PERMITS & FEES

All Bidders awarded a contract must secure and pay for any licenses required by the City of Evanston. Necessary building permits will be required, but all permit fees will be waived and moneys for same must not be included in any bid.

26. ROYALTIES & PATENTS

Seller must pay all royalties and license fees. Seller must defend all suits or claims for infringement of any patent, copyright or trademark rights, and must hold the City harmless from loss on account thereof.

27. LOCAL PREFERENCE POLICY

The Evanston City Council reserves the right to award the contract to an Evanston firm if the firm's bid is within five (5%) percent of the low bid of a non-Evanston firm.

28. POWER OF ATTORNEY

An Attorney-In-Fact, who signs any and all of the bond or contract bonds submitted with this bid, must file with each bond a certified and effectively dated copy of their Power of Attorney. These dates should be the same or after the date of the contract.

29. WARRANTY

- A. The contractor warrants that all goods and services furnished to the City shall be in accordance with specifications and free from any defects of workmanship and materials: that goods furnished to the City shall be merchantable and fit for the City's described purposes, and that no governmental law, regulation, order, or rule has been violated in the manufacture or sale of such goods.
- B. The contractor warrants all equipment furnished to be in acceptable condition, and to operate satisfactorily for a period of one (1) year from delivery of, or the completion of installation, whichever is latest, unless stated otherwise in the specifications, and that if a defect in workmanship and/or quality of materials are evidenced in this period, the Seller shall remit full credit, replace, or repair at City's discretion immediately, such equipment and/or parts that are defective at no additional cost to the City.
- C. The contractor warrants to the City that each item furnished hereunder, and any component part thereof, will be new and in conformity with the specifications in all respects, unless otherwise specified, and is of the best quality of its respective kind, free from faulty workmanship, materials, or design, and installed sufficiently to fulfill any operating conditions specified by the City.
- D. The contractor shall repair or replace any item or component part thereof found not to be in conformity with this paragraph provided the City notified the Seller of such nonconformity within one (1) year after initial use or within eighteen (18) months after delivery, whichever occurs first. In the event Seller fails to proceed diligently to so replace or repair within a reasonable time after receipt of such notice, the City may undertake or complete such replacement or repair for Seller's account, and the seller will be responsible for any additional costs. Acceptance shall not relieve the seller of its responsibility.

30. INCURRED COSTS

The City will not be liable for any costs incurred by Bidders in replying to this invitation for bids.

31. VARIANCES

Each Bidder must state or list by reference any variations to specifications, terms and/or conditions set forth herein with its bid.

32. INDEMNIFICATION

- A. The awarded Bidder/Contractor shall defend, indemnify and hold harmless the City and its officers, elected and appointed officials, agents, and employees from any and all liability, losses, or damages as a result of claims, demands, suits, actions, or proceedings of any kind or nature, including but not limited to costs, and fees, including attorney's fees, judgments or settlements, resulting from or arising out of any negligent or willful act or omission on the part of the Contractor or Contractor's sub-contractors, employees, agents or sub-contractors during the performance of this Agreement. Such indemnification shall not be limited by reason of the enumeration of any insurance coverage herein provided. This provision shall survive completion, expiration, or termination of this Agreement.
- B. Nothing contained herein shall be construed as prohibiting the City, or its officers, agents, or employees, from defending through the selection and use of their own agents, attorneys, and experts, any claims, actions or suits brought against them. The Contractor shall be liable for the reasonable costs, fees, and expenses incurred in the defense of any such claims, actions, or suits. Nothing herein shall be construed as a limitation or waiver of defenses available to the City and employees and agents, including but not limited to the Illinois Local Governmental and Governmental Employees Tort Immunity Act, 745 ILCS 10/1-101 *et seq.*
- C. At the City Corporation Counsel's option, Contractor must defend all suits brought upon all such Losses and must pay all costs and expenses incidental to them, but the City has the right, at its option, to participate, at its own cost, in the defense of any suit, without relieving Contractor of any of its obligations under this Agreement. Any settlement of any claim or suit related to this Project by Contractor must be made only with the prior written consent of the City Corporation Counsel, if the settlement requires any action on the part of the City.
- D. To the extent permissible by law, Contractor waives any limits to the amount of its obligations to indemnify, defend, or contribute to any sums due under any Losses, including any claim by any employee of Contractor that may be subject to the Illinois Compensation Act, 820 ILCS 305/1 *et seq.* or any other related law or judicial decision, including but not limited to, *Kotecki v. Cyclops Welding Corporation*, 146 Ill. 2d 155 (1991). The City, however, does not waive any limitations it may have on its liability under the Illinois Workers Compensation Act, the Illinois Pension Code or any other statute.

- E. The Contractor shall be responsible for any losses and costs to repair or remedy work performed under this Agreement resulting from or arising out of any act or omission, neglect, or misconduct in the performance of its Work or its sub-contractors' work. Acceptance of the work by the City will not relieve the Contractor of the responsibility for subsequent correction of any such error, omissions and/or negligent acts or of its liability for loss or damage resulting therefrom.
- F. All provisions of this Section 32 shall survive completion, expiration, or termination of this Agreement.

33. DEFAULT

Time is of the essence as to the awarded contract and, of delivery or acceptable items or rendering of services is not completed by the time promised, the City reserves the right, without liability, in addition to its other rights and remedies, to terminate the contract by notice effective when received by Seller, as to stated items not yet shipped or services not yet rendered and to purchase substitute items or services elsewhere and charge the Seller with all losses incurred. The City shall be entitled to recover its attorney's fees and expenses in any successful action by the City to enforce this contract.

34. GOVERNING LAW

This contract shall be governed by and construed according to the laws of the State of Illinois. In the event of litigation, the venue will be Cook County, Illinois.

35. EQUAL EMPLOYMENT OPPORTUNITY

- A. In the event of the contractor's noncompliance with any provision of the Illinois Human Rights Act or Section 1-12-5 of the Evanston City Code, the contractor may be declared non-responsible and therefore ineligible for future contracts or sub-contracts with the City of Evanston, and the contract may be canceled or voided in whole or in part, and such other sanctions or penalties may be imposed or remedies invoked as provided by Statute or regulation.
- B. During the performance of this contract, the contractor agrees as follows:
 - 1. That it will not discriminate against any employee or applicant for employment because of race, color, religion, sex, national origin or ancestry, or age or physical or mental handicap that does not impair ability to work, and further that it will examine all job classifications to determine if minority persons or women are underutilized and will take appropriate affirmative action to rectify any such underutilization. Contractor shall comply with all requirements of City of Evanston Code Section 1-12-5.
 - 2. That, in all solicitations or advertisements for employees placed by it or on its behalf, it will state that all applicants will be afforded equal opportunity without discrimination because of race, color, religion, sex, national origin or ancestry.

3. That, if it hires additional employees in order to perform this contract, or any portion hereof, it will determine that availability (in accordance with the Fair Employment Commission's Rules and Regulations for Public Contracts) of minorities and women in the area(s) from which it may reasonably recruit and it will hire for each job classification for which employees are hired in such a way that minorities and women are not underutilized.
4. That it will send to each labor organization or representative of workers with which it has or is bound by a collective bargaining or other agreement or understanding, a notice advising such labor organization or representative of the contractor's obligations under the Illinois Fair Employment Practices Act and the Fair Employment Practices Commission's Rules and Regulations for Public Contracts. If any such labor organization or representative fails or refuses to cooperate with the contractor in its efforts to comply with such Act and Rules and Regulations, the contractor will promptly so notify the Illinois Fair Employment Practices Commission and the contracting agency and will recruit employees from other sources when necessary to fulfill its obligations hereunder.
5. That it will submit reports as required by the Illinois Fair Employment Practices Commission's Rules and Regulations for Public Contracts, furnish all relevant information as may from time to time be requested by the Fair Employment Practices Commission or the contracting agency, and in all respects comply with the Illinois Fair Employment Practices Commission's Rules and regulations for Public Contracts.
6. That it will permit access to all relevant books, records, accounts and work sites by personnel of the contracting agency, the City Manager, the Commission and the Illinois Fair Employment Practices Commission for purposes of investigation to ascertain compliance with the Illinois Fair Employment Practices Act and the Fair Employment Practices Act and the Fair Employment Practices Commission's Rules and Regulations for Public Contract.
7. That it will include verbatim or by reference the provisions of subsections (A) through (G) of this clause in every performance sub-contract as defined in Section 2.10(b) of the Fair Employment Practices Commission's Rules and Regulations for Public Contracts so that such provisions will be binding upon every such sub-contractor; and that it will also include the provisions of subsections (A), (E), (F), and (G) in every supply sub-contract as defined in Section 2.10(a) of the Fair Employment Practices Commission's Rules and Regulations for Public Contracts so that such provisions will be binding upon every such sub-contractor. In the same manner as with other provisions of this contract, the contractor will be liable for compliance with applicable provisions of this clause by all its sub-contractors; and further it will promptly notify the

contracting agency and the Illinois Fair Employment Practices Commission in the event any sub-contractor fails or refuses to comply therewith. In addition, no contractor will utilize any sub-contractor declared by the Fair Employment Practices Commission to be non-responsible and therefore ineligible for contracts or sub-contracts with the State of Illinois or any of its political subdivisions or municipal corporations.

36. M/W/EBE GOAL

The City of Evanston has a goal of awarding 25% of its contracts to Minority-Owned, Women-Owned, and Evanston-based businesses (M/W/EBEs). All Bidders must state the proposed involvement of M/W/EBEs in completing a portion of the services required by the City by completing the attached M/W/EBE forms. Any questions regarding M/W/EBE compliance should be submitted in writing to Tammi Nunez, Purchasing Manager at tnunez@cityofevanston.org.

37. LOCAL EMPLOYMENT PROGRAM REQUIREMENTS

In an effort to increase hiring of economically disadvantaged Evanston residents on certain City construction projects, the contractor shall comply with the provisions of the City of Evanston's Local Employment Program Ordinance (LEP) set forth in Section 1-17-1 (C) of the Evanston City Code. The intent of the LEP is to have Evanston residents employed at the construction site as laborers, apprentices and journeymen in such trades as electrical, HVAC, carpenters, masonry, concrete finishers, truck drivers and other construction occupations necessary for the project. Any questions regarding LEP compliance should be submitted in writing to Tammi Nunez Purchasing Manager at tnunez@cityofevanston.org.

[NOTE: CITY OF EVANSTON ORDINANCE 60-O-14 AMENDMENT LOCAL EMPLOYMENT PROGRAM \(LEP\) available on the City website at: Ordinance 60-O-14 Amendment LEP](#)

38. Questions

All questions related to this bid document should be submitted in writing to Linda Thomas, Purchasing Specialist at litomas@cityofevanston.org with a copy to Stefanie Levine, at slevine@cityofevanston.org. Only inquiries received a minimum of seven (7) working days prior to the date set for the opening of bids, will be given any consideration.

39. COORDINATION OF EXISTING SITE WITH DRAWINGS

- A. Before submitting a bid, bidders shall carefully examine the drawings and specifications, visit the site, and fully inform themselves as to all conditions and limitations.
- B. Should a bidder find discrepancies in, or omissions from the drawings or specifications, or should be in doubt as to their meaning, the bidder should at once notify the Purchasing Specialist, who will issue necessary instructions to all bidders in the form of an addendum.

40. AFFIRMATIVE ACTION IN SUB-CONTRACTING (EXCERPT FROM RESOLUTION 59-R-73)

“Contractor agrees that he shall actively solicit bids for the sub-contracting of goods or services from qualified minority businesses. At the request of the City, Contractor shall furnish evidence of his compliance with this requirement of minority solicitation. Contractor further agrees to consider the grant of sub-contracts to said minority bidders on the basis of substantially equal bids in the light most favorable to said minority businesses. Contractor further affirms that in obtaining his performance and bid bonds, he will seek out and use companies who have records of, and/or who will make commitments to, the bonding of minority contractors on a rate basis comparable to their bonding of similar non-minority contractors. The contractor may be required to submit this evidence as part of the bid or subsequent to it.”

41. COMPLIANCE WITH LAWS

- A. The bidder shall at all times observe and comply with all laws, ordinances and regulations of the Federal, State, Local and City Governments, which may in any manner affect the preparation of bids or the performance of the contract.

42. QUALIFICATION OF BIDDERS

- A. All bidders must be qualified in accordance with the instructions, procedures and methods set forth in this specification.
- B. In awarding contract, City may take into consideration, skill, facilities, capacity, experience, ability, responsibility, previous work, financial standing of bidder, amount of work being carried on by bidder, quality and efficiency of construction equipment proposed to be furnished, period of time within which proposed equipment is furnished and delivered, necessity of prompt and efficient completion of work herein described. Inability of any bidder to meet requirements mentioned above may be cause for rejection of the bid. In addition, if the project covered by this contract is a minority set-aside project, the contractor's qualifications as a minority firm will determine the eligibility of the contractor to bid.

43. COMPETENCY OF BIDDER

- A. No bid will be accepted from or contract awarded to any person, firm or corporation that is in arrears or is in default to the City of Evanston upon any debt or contract, or that is a defaulter, as surety or otherwise, upon any obligation to said City, or had failed to perform faithfully any previous contract with the City.
- B. The bidder, if requested, must present within forty eight (48) hours evidence satisfactory to the Purchasing Manager of performance ability and possession of necessary facilities, pecuniary resources and adequate insurance to comply with the terms of these specifications and contract documents.

44. PREFERENCE TO CITIZENS

The Contractor shall abide by the Illinois Preference Act, 30 ILCS 570 et seq.,

which stipulates that whenever there is a period of excessive unemployment in Illinois, defined as any month immediately following two (2) consecutive months during which the level of unemployment in Illinois exceeds five percent (5%) as measured by the U.S. Bureau of Labor Statistics in its monthly publication of employment and unemployment figures, the Contractor shall employ only Illinois laborers unless otherwise exempted as so stated in the Act. ("Illinois laborer" means any person who has resided in Illinois for at least 30 days and intends to become or remain an Illinois resident) Other laborers may be used IF Illinois laborers are not available or are incapable of performing the particular type of work involved if so certified by the Contractor and approved by the project engineer.

GENERAL CONDITIONS

1. BASIS OF AWARD

The City of Evanston reserves the right to award a contract to a responsive and responsible Bidder(s) who submits the lowest total bid, or to reject any or all bids and bidding, when in its opinion the best interest of the City will be served by such action. The City reserves the right to consider the specified alternates in its evaluation of the bids.

2. BIDS

A. LUMP SUM BID

1. The bidder is to submit a lump sum bid for each bid line on the Bid Form which includes all costs incidental to performing the specified work. It is understood and agreed that the unit quantities given in the supporting pages are approximate only and the bidder shall verify these quantities before bidding as no claim shall be made against the City on account of any excess or deficiency in the same.

2. Unit prices given in the supporting pages shall be used by the City and the Contractor for any subsequent changes in the contract.

3. QUANTITIES

Any quantities shown on the Bid Form are estimated only for bid canvassing purposes, the City has made a good faith effort to estimate the quantity requirements for the Contract term. The City reserves the right to increase or decrease quantities ordered under this contract.

4. CONTRACT TERM

Bidder must fully complete the work within the period specified herein after award of the contract by the City.

5. NOTICE TO PROCEED/ PURCHASE ORDER/ CONTRACT

A. The City issued Purchase Order serves as the City official Notice to Proceed. No work will be allowed prior to Contractor receipt of the City issued Purchase Order.

B. Upon approval of the required bonds and insurance documents, the City will issue a Purchase Order to the Contractor for the contract amount. All Applications for Payment must reference the Purchase Order number.

C. When it is necessary to issue a Change Order that increases/decreases the contract amount, a Change Order form will be issued and a modified Purchase Order will be issued reflecting the revised contract amount.

D. When it is necessary to issue a Change Order that only increases/decreases the contract period, only a Change Order form will be issued establishing the revised

contract period.

- E. Upon Award the contractor shall execute the Contractor Services Agreement.

6. PAYMENT

- A. Progress payments will be made in accordance with “Applications for Payment” and “Project Closeout” sections of the specifications, less a 10% retainage for each payment, which will be held until final acceptance of the work by the City. Certification of each Application for Payment will be made by the City’s representative.
- B. All payments will be made in accordance with *Illinois Local Government Prompt Payment Act*.

7. DECISIONS TO WITHHOLD CERTIFICATION FOR PAYMENT

- A. The City may not certify payment and may withhold payment in whole or in part, to the extent reasonably necessary to protect the City, if the quality of the work is not in accordance with the contract documents. If the City is unable to certify payment in the amount of the invoice, the City will promptly issue payment for the amount of the Work completed in accordance with the contract documents. The City may not certify payment due to any contractor negligence or contract non-compliance.
 - a. Defective work not remedied
 - b. Third party claims filed or reasonable evidence indicating probable filing of such claims
 - c. Failure of Contractor to make payments properly to Sub-contractors for labor, materials or equipment
 - d. Reasonable evidence that the work cannot be completed for the unpaid balance of the Contract Sum
 - e. Damage to the City or another contractor
 - f. Reasonable evidence that the work will not be completed within the Contract period and that the unpaid balance would not be adequate to cover actual or liquidated damages for the anticipated delay
 - g. Persistent failure to carry out work in accordance with the Contract Documents.

8. CHANGES IN WORK

- A. The City reserves the right to make changes in the plans and specifications by altering, adding to, or deducting from the work, without invalidating the contract. All such changes shall be executed under the conditions of the original contract, except that any claim for extension of time caused thereby shall be adjusted at the time of ordering such change.
- B. No change shall be made unless a written Change Order and/or modified Purchase Order is issued by the City stating that the City has authorized the change, and no claim for an addition to the contract shall be valid unless so ordered.

- C. If such changes diminish the quantity of work to be done they shall not constitute a claim for damage or anticipated profits on the work, such increase shall be paid in one or more of the following ways:
 - 1. by estimate and acceptance in lump sum
 - 2. by unit prices named in the contract's bid form or subsequently agreed upon

9. DEDUCTION FOR UNCORRECTED WORK

If the City deems it expedient to correct work damaged or not done in accordance with the contract, the difference in value, together with a fair allowance for damage shall be deducted from the contract amount due. The value of such deduction shall be determined by the City.

10. CITY'S RIGHT TO TERMINATE CONTRACT

The City reserves the right, in addition to other rights to termination, to terminate the contracts in accordance with all provisions of the executed contract.

11. LIENS

- A. Neither the final payment nor any part of any retained percentages, shall become due until the contractor, if required, delivers to the City, a complete release of all liens arising out of this contract, or receipts in full in lieu thereof and, if required in either case, an affidavit that so far as it has knowledge or information the releases and receipts include all the labor and material for which a lien could be filed. If any lien remains unsatisfied after all payments are made the contractor shall refund to the City all moneys that the latter may be compelled to pay in discharging such a lien, including all costs and attorney's fees.

12. SEPARATE CONTRACTS

- A. The City reserves the right to let other contracts in connection with this work. The contractor shall afford other contractors reasonable opportunity for the introduction and storage of their materials and the execution of their work and shall properly connect and coordinate his or her work with theirs. If any part of the contractor's work depends on proper execution or results upon the work of any other contractor, the contractor shall inspect and promptly report to the City any defects in such work that render it unsuitable for such proper execution and results. His or her failure to so inspect and report shall constitute an acceptance of other contractor's work as fit and proper.
- B. To insure the proper execution of his or her subsequent work, the contractor shall measure work already in place and shall at once report to the City any discrepancy between the executed work and the drawings which will affect his or her work.

13. PROTECTION & SAFEGUARDS

- A. Unless otherwise specified, the contractor, as a part of this contract, shall provide, erect and maintain temporary roads, fences, bracing, lights, warning signs,

barricades, etc. necessary for the protection of the construction materials, adjacent property and the public.

- B. The contractor shall contact all utilities which will be affected by its operations and notify the owners of the utilities of its operations and their limits within forty-eight (48) hours prior to beginning construction. The contractor shall be responsible for damage to utilities and shall, at his or her own expense, restore such property to a condition equal to that which existed before its work, as may be directed by the owners.
- C. The contractor shall protect all work and unused materials of this contract from any and all damage and shall be solely responsible for the condition of such work and materials.

14. MATERIAL STORAGE

- A. On-site areas may be designated for material/equipment storage. The contractor will assume all risk and liability associated with the storage of material/equipment at on-site locations.

15. CLEANING UP

- A. The contractor shall at all time keep the premises free from accumulation of waste material or rubbish caused by its employees or work and at the completion of the work it shall remove all its rubbish, tools, and surplus materials from the premises, leaving the area in a neat and workmanlike condition. In case of dispute, the City may remove the rubbish and charge the cost to the contractor.
- B. Contractor recognizes that proper cleanup and removal of construction debris is an important safety consideration. The Contractor shall be solely responsible for daily construction site/area cleanup and removal of all construction debris in accordance with City-approved disposal practices. Contractor shall be solely responsible for identifying and removing at its expense all hazardous material and waste which it uses and generates.

16. RESTORATION OF SITE

- A. Prior to final payment, contractor shall fully restore all property disturbed or damaged during the course of this work. This includes, but is not limited to public property, (walks, curbs, roadways, trees, etc.) private property, and utilities. This shall also include removal of temporary facilities erected during the course of this contract and restoration of these areas.
- B. All restoration work shall be subject to the approval of the City and shall restore the property to a condition at least equal to that existing prior to the start of this contract.
- C. All restoration work of property damaged by contractor shall be accomplished at the sole expense of the contractor.

17. PREVAILING WAGE

- A. Prospective Bidders shall thoroughly familiarize themselves with the provisions of the above-mentioned Act and shall prepare any and all bids/bids in strict compliance therewith.

- B. **Effective September 1st - All work performed on new and existing projects must be submitted to Illinois Department of Labor through the certified transcript of payroll portal.** You may access the portal here: [Certified Transcript of Payroll Portal](#)

All contractors and sub-contractors on public works projects **must submit and upload certified payrolls** on a monthly basis to the **IDOL** online portal, provide a pdf copy to the City's project manager and business work force development coordinator, along with a statement affirming that such records are true and accurate, that the wages paid to each worker are not less than the required prevailing rate and that the contractor is aware that filing records her or she knows to be false is a Class B misdemeanor.

- C. The certified payroll record must include for every worker employed on the public works project the name, address, telephone number, social security number, job classification, hourly wages paid in each pay period, number of hours worked each day, and starting and ending time of work each day. These certified payroll records are considered public records and public bodies must make these records available to the public under the Freedom of Information Act, with the exception of the employee's address, telephone number and social security number. Any contractor who fails to submit a certified payroll or knowingly files a false certified payroll is guilty of a Class B misdemeanor.

- D. All certified payrolls shall be submitted in electronic format, preferably a PDF file.

- E. As a condition of receiving payment, Contractor must (i) be in compliance with the Agreement, (ii) pay its employees prevailing wages when required by law (Examples of prevailing wage categories include public works, printing, janitorial, window washing, building and grounds services, site technician services, natural resource services, security guard and food services). Contractor is responsible for contacting the Illinois Dept. of Labor 217-782-1710; <https://www2.illinois.gov/idol/Laws-Rules/CONMED/Pages/prevailing-wage-act.aspx> compliance with prevailing wage requirements), (iii) pay its suppliers and sub-contractors according to the terms of their respective contracts, and (iv) provide lien waivers to the City upon request.

18. CONTRACTOR REQUIREMENTS

- A. The Contractor shall abide by and comply with all local, State and federal laws and regulations relating to contracts involving public funds and the development/construction of public works, buildings, or facilities. The scale of wages to be paid shall be obtained from Illinois Department of Labor and posted by the Contractor in a prominent and accessible place at the project work site.

- B. The Contractor certifies it has not been barred from being awarded a contract with a unit of State or local government as a result of bid rigging or bid rotating or any similar offense (720 ILCS 5/33 E-3, E-4).
- C. The Contractor certifies, pursuant to the Illinois Human Rights Act (775 ILCS 5/2-105), that it has a written sexual harassment policy that includes, at a minimum, the following information: (1) the illegality of sexual harassment, (2) the definition of sexual harassment under State law, (3) a description of sexual harassment utilizing examples, (4) the Contractor's internal complaint process including penalties, (5) legal recourse, investigation and complaint process available through the Illinois Department of Human Rights and the Human Rights Commission and directions on how to contact both; and (6) protection against retaliation as provided by Section 6-101 of the Illinois Human Rights Act.
- D. The Contractor shall abide by the "Illinois Preference Act" which stipulates that whenever there is a period of excessive unemployment in Illinois, defined as any month immediately following two (2) consecutive months during which the level of unemployment in Illinois exceeds five percent (5%) as measured by the U.S. Bureau of Labor Statistics in its monthly publication of employment and unemployment figures, the Contractor shall employ only Illinois laborers unless otherwise exempted as so stated in the Act. ("Illinois laborer" means any person who has resided in Illinois for at least 30 days and intends to become or remain an Illinois resident) Other laborers may be used IF Illinois laborers are not available or are incapable of performing the particular type of work involved if so certified by the Contractor and approved by the project engineer.

19. SUB-CONTRACTORS

- A. The term "sub-contract" means any agreement, arrangement or understanding, written or otherwise between a Contractor and any person (in which the parties do not stand in the relationship of an employer or an employee) for the furnishing of supplies or services or for the use of real or personal property, including lease arrangements, which, in whole or in part, is utilized in the performance of any one or more Contracts under which any portion of the Contractor's obligation under any one or more Contracts is performed, undertaken or assumed.
- B. The Bidder is specifically advised that any person, firm or party, to whom it is proposed to award a sub-contract under this contract must be acceptable to the City. Approval for the proposed sub-contract Award cannot be given by the City until the proposed Sub-contractor has submitted evidence showing that it has fully complied with any reporting requirements to which it is, or was, subject.
- C. The contractor, shall, within ten (10) days after award of the Contract, submit to the City in writing, names and addresses and respective amounts of money for proposed contracts with Sub-contractors/major suppliers. The City will review and may direct the Contractor that they shall not employ any that are not acceptable as

provided above.

- D. The sub-contractor shall abide by and comply with all local, State and federal laws and regulations relating to contracts involving public funds and the development/construction of public works, buildings, or facilities.

20. PAYMENTS TO SUB-CONTRACTORS

- A. Within seven days after the receipt of amounts paid by the City for work performed by a sub-contractor under this contract, the Contractor shall either:
 - 1. Pay the sub-contractor for the proportionate share of the total payment received from the City attributable to the work performed by the sub-contractor under this contract; or,
 - 2. Notify the City and sub-contractor, in writing, of his intention to withhold all or a part of the sub-contractor's payment and the reason for non-payment.
- B. The Contractor shall pay interest to the sub-contractor on all amounts owed that remain unpaid beyond the seven day period except for amounts withheld as allowed in item 2 above.
- C. Unless otherwise provided under the terms of this contract, interest shall accrue at the rate of one percent per month.
- D. The Contractor shall include in each of its sub-contracts a provision requiring each Sub-contractor to include or otherwise be subject to the same payment and interest requirements as set forth above with respect to each lower-tier sub-contractor.
- E. The Contractor's obligation to pay an interest charge to a sub-contractor pursuant to this provision may not be construed to be an obligation of the City.

21. BOND – PERFORMANCE, MATERIAL, & LABOR

- A. When required by the specifications herein, the successful Bidder or Bidders shall, within ten (10) calendar days after acceptance of the Bidder's bid by the City, furnish a performance bond for 100% of the full amount of the contract from insurance companies having not less than A+ Policyholders Rating from the most recent Alfred M. Best and Co., Inc. listing available. Certification of the insurance company's rating shall be provided prior to contract implementation and quarterly thereafter until contract completion. Should such rating fall below the required A+ level during performance of the contract, it will be the contractor's responsibility to notify the City and provide a new bond from an insurance company whose rating meets the City's requirements.
- B. When required by the specifications herein, all Bidders shall submit with the bid a bid bond. A letter of credit may be furnished in lieu of a bid bond only if the

following conditions are met: 1) An irrevocable letter of credit must be obtained from an accredited bank which shall include an agreement that the bank will honor a demand by the City for payment due to Plaintiff failure to complete the project. 2) An irrevocable letter of credit must be in writing and signed by an authorized representative of the bank. 3) The irrevocable letter of credit must expressly state that it is irrevocable until the bid has been awarded. 4) The letter of credit must be for the percentage specified in the bid documents.

- C. The City may reject the use of an irrevocable letter of credit if the financial soundness of the issuing bank is found to be unacceptable.
- D. In the event that the Bidder fails to furnish a performance bond in said period of ten (10) calendar days after acceptance of the Bidder's bid by the City, the City may withdraw its acceptance of the bid and retain the Bidder's deposit as liquidated damages and not as a penalty.
- E. If the contractor has more than one project for which there is a contract with the City of Evanston the contractor shall provide a separate Performance Bond for each project.

22. INDEMNITY

- A. The Contractor shall defend, indemnify and hold harmless the City and its officers, elected and appointed officials, agents, and employees from any and all liability, losses, or damages as a result of claims, demands, suits, actions, or proceedings of any kind or nature, including but not limited to costs, and fees, including attorney's fees, judgments or settlements, resulting from or arising out of any negligent or willful act or omission on the part of the Contractor or Contractor's sub-contractors, employees, agents or sub-contractors during the performance of this Agreement. Such indemnification shall not be limited by reason of the enumeration of any insurance coverage herein provided. This provision shall survive completion, expiration, or termination of this Agreement.
- B. Nothing contained herein shall be construed as prohibiting the City, or its officers, agents, or employees, from defending through the selection and use of their own agents, attorneys, and experts, any claims, actions or suits brought against them. The Contractor shall be liable for the reasonable costs, fees, and expenses incurred in the defense of any such claims, actions, or suits. Nothing herein shall be construed as a limitation or waiver of defenses available to the City and employees and agents, including but not limited to the Illinois Local Governmental and Governmental Employees Tort Immunity Act, 745 ILCS 10/1-101 *et seq.*
- C. At the City Corporation Counsel's option, Contractor must defend all suits brought upon all such Losses and must pay all costs and expenses incidental to them, but the City has the right, at its option, to participate, at its own cost, in the defense of any suit, without relieving Contractor of any of its obligations under this Agreement. Any settlement of any claim or suit related to this Project by Contractor must be

made only with the prior written consent of the City Corporation Counsel, if the settlement requires any action on the part of the City.

- D. To the extent permissible by law, Contractor waives any limits to the amount of its obligations to indemnify, defend, or contribute to any sums due under any Losses, including any claim by any employee of Contractor that may be subject to the Illinois Workers Compensation Act, 820 ILCS 305/1 et seq. or any other related law or judicial decision, including but not limited to, Kotecki v. Cyclops Welding Corporation, 146 Ill. 2d 155 (1991). The City, however, does not waive any limitations it may have on its liability under the Illinois Worker Compensation Act, the Illinois Pension Code or any other statute.
- E. The Contractor shall be responsible for any losses and costs to repair or remedy work performed under this Agreement resulting from or arising out of any act or omission, neglect, or misconduct in the performance of its Work or its sub-contractors' work. Acceptance of the work by the City will not relieve the Contractor of the responsibility for subsequent correction of any such error, omissions and/or negligent acts or of its liability for loss or damage resulting therefrom.

23. CONTRACTOR'S LIABILITY INSURANCE

- A. THE CONTRACTOR SHALL NOT COMMENCE WORK UNDER THIS CONTRACT UNTIL THEY HAVE OBTAINED ALL INSURANCE REQUIRED HEREIN AND SUCH INSURANCE HAS BEEN APPROVED BY THE CITY. Nor shall the contractor allow any sub-contractor to commence work until all similar insurance required of the sub-contractor has been so obtained.
- B. The City of Evanston shall be named as an additional insured on the policy of the contractor for whatever the policy limits are for the contractor, but in no event shall the Comprehensive General Liability limits be less than \$3,000,000.00.
- C. If the contractor has more than one project for which he has a contract with the City of Evanston there shall be separate Certificates of Insurance naming the City as an additional insured on each separate policy.
- D. In the event of accidents, injuries, or unusual events, whether or not any injury occurred, the contractor shall promptly furnish the City with copies of all reports of such incidents.
- E. The contractor shall furnish one (1) copy of a certificate, with the City named as an additional insured, showing the following minimum coverage with insurance company acceptable to the City.

24. PRE-CONSTRUCTION MEETING

- A. A pre-construction meeting will be scheduled for the successful Contractor at a date immediately following awarding of the Contracts.

25. LIQUIDATED DAMAGES

- A. The Contractor shall, and agrees to pay, per calendar day, the amount listed in the Schedule of Deductions presented in Article 108.09 of the Standard Specifications (based upon the total Contract Price) as liquidated damages for failure to meet the completion deadlines identified below:

Substantial Completion Deadline: June 30, 2023
Final Completion Deadline: July 28, 2023

- B. Substantial Completion shall be defined as the stage in the progress of the work when the work or designated portion thereof is sufficiently complete in accordance with the Contract Documents so that the City can occupy or utilize the work for its intended use. Substantial Completion will be certified by the issuance of a Certificate of Substantial Completion, to be issued by the City's representative, when the Contractor has satisfied the above statement.
- C. Final Completion shall be defined as the stage in the progress of the work when all work on site is fully complete, including punch list work.

26. EXTENSION OF TIME

- A. Delays due to causes beyond the control of the contractor other than such as reasonable would be expected to occur in connection with or during the performance of the work, may entitle the contractor to an extension of time for completing the work sufficient to compensate for such delay. No extension of time shall be granted, however, unless the contractor shall notify the City in writing thereof, within ten (10) days from the initiation of the delay and unless he shall, within ten (10) days after the expiration of the delay, notify the City in writing of the extension of time claimed on account thereof and then only to the extent, if any, allowed by the City.

27. DEFAULT

- A. The City may, subject to the provisions of this section, by written notice of default to Contractor, terminate the whole or any part of this contract in any one of the following circumstances:
1. if the Contractor fails to perform the services within the time specified herein, or any extension thereof; or
 2. if the contractor fails to perform any of the other provisions of this contract, or so fails to make progress as to endanger performance of this contract in accordance with its terms, and in either of these two circumstances does not cure failure within a period of 10 days (or such other extended period as the City may authorize in writing) after receipt of notice from the City specifying such failure
- B. In the event the City terminates this contract in whole or in part as provided in this section, the City may procure, upon such terms and in such manner as the City

may deem appropriate, services similar to those so terminated, and the Contractor will be liable to the City for any excess costs for such similar services.

- C. The Contractor will not be liable for any excess of costs if acceptable evidence has been submitted to the City that the failure to perform the contract was due to causes beyond the control and without fault or negligence of the Contractor.
- D. Contractors who default may not be considered for awards of future City contracts.

28. USE OF PREMISES

- A. The contractor shall confine his apparatus, the storage of materials and the operations of his workers, to limits indicated by law, ordinances, permits or directions of the City.

29. DISCLOSURES AND POTENTIAL CONFLICTS OF INTEREST (30 ILCS 500/50-35)

- A. The City of Evanston's Code of Ethics prohibits public officials or employees from performing or participating in an official act or action with regard to a transaction in which he has or knows he will thereafter acquire an interest for profit, without full public disclosure of such interest. This disclosure requirement extends to the spouse, children and grandchildren, and their spouses, parents and the parents of a spouse, and brothers and sisters and their spouses.

To ensure full and fair consideration of all bids, the City of Evanston requires all Bidders including owners or employees to investigate whether a potential or actual conflict of interest exists between the Bidder and the City of Evanston, its officials, and/or employees. If the Bidder discovers a potential or actual conflict of interest, the Bidder must disclose the conflict of interest in its bid, identifying the name of the City of Evanston official or employee with whom the conflict may exist, the nature of the conflict of interest, and any other relevant information. The existence of a potential or actual conflict of interest does NOT, on its own, disqualify the disclosing Bidder from consideration. Information provided by Bidders in this regard will allow the City of Evanston to take appropriate measures to ensure the fairness of the bidding process.

The City of Evanston requires all bidders to submit a certification, enclosed with this bid packet, that the bidder has conducted the appropriate investigation and disclosed all potential or actual conflicts of interest.

By submitting a bid, all Bidders acknowledge and accept that if the City of Evanston discovers an undisclosed potential or actual conflict of interest, the City of Evanston may disqualify the Bidder and/or refer the matter to the appropriate authorities for investigation and prosecution.

INSURANCE REQUIREMENTS

<u>TYPE OF INSURANCE</u>	<u>MINIMUM</u>	<u>INSURANCE</u>	<u>COVERAGE</u>
	Consequent Death		Bodily Injury and Property Damage
	Each Occurrence		Aggregate
Commercial General Liability including:	\$3,000,000		\$3,000,000
1. Comprehensive form			
2. Premises - Operations			
3. Explosion & Collapse Hazard			
4. Underground Hazard			
5. Products/Completed Operations Hazard			
6. Contractual Insurance – With an endorsement on the face of the certificate that it includes the "Indemnity" paragraph of the specifications.			
7. Broad Form Property Damage - construction projects only			
8. Independent contractors			
9. Personal Injury			
Automobile Liability Owned, Non-owned or Rented	\$ 1,000,000		\$1,000,000
Workmen's Compensation and Occupational Diseases As required by applicable laws. Employer's Liability			\$ 500,000

**Insurance Certificate Must State:
The City Of Evanston is Named
as Additional Insured**

Thirty day notice of cancellation required on all certificates.

EXHIBIT A – BID FORM
For
Robert Crown Community Center
Gymnasium Acoustic Panel Installation

(BID #23-22)

1.01 BID TO:

THE CITY OF EVANSTON

2100 Ridge Avenue
Evanston, Illinois 60201

Hereinafter called "OWNER".

1.02 BID FROM:

(Hereinafter call "BIDDER")

Address

Telephone Number

Fax Number

1.03 BID FOR: **ROBERT CROWN COMMUNITY CENTER GYMNASIUM ACOUSTIC PANEL INSTALLATION**

1.04 ACKNOWLEDGEMENT:

A. The Bidder, in compliance with the Invitation for Bids, having carefully examined the Drawings and Project Manual with related documents and having visited the site of the proposed Work, and being familiar with all of the existing conditions and limitations surrounding the construction of the proposed project, including the structure of the ground, subsurface conditions, the obstacles which may be encountered, local restrictions, and all other relevant matters concerning the Work to be performed, hereby PROPOSES to perform everything required to be performed, and to provide all labor, materials, necessary tools and equipment, expendable equipment, all applicable permits and taxes and fees, and provide all utility and

transportation services necessary to perform and complete in a workmanlike manner the Project in accordance with all the plans, specifications and related Contract Documents as prepared by the City of Evanston.

- B. The undersigned hereby acknowledges receipt of Invitation of Bids, Instruction to Bidder, the Project Manual, Drawings, and other Contract Documents and acknowledges receipt of the following Addenda:

Addendum No. _____ Dated _____
Addendum No. _____ Dated _____
Addendum No. _____ Dated _____

1.05 GENERAL STATEMENTS

- A. The undersigned has checked all of the figures contained in this proposal and further understands that the Owner will not be responsible for any errors or omissions made therein by the undersigned.
- B. It is understood that the right is reserved by the Owner to reject any or all proposals, to waive all informality in connection therewith and to award a Contract for any part of the work or the Project as a whole.
- C. The undersigned declares that the person(s) signing this proposal is/are fully authorized to sign on behalf of the named firm and to fully bind the named firm to all the conditions and provisions thereof.
- D. It is agreed that no person(s) or company other than the firm listed below or as otherwise indicated hereinafter has any interest whatsoever in this proposal or the Contract that may be entered into as a result thereof, and that in all respects the proposal is legal and fair, submitted in good faith, without collusion or fraud.
- E. It is agreed that the undersigned has complied and/or will comply with all requirements concerning licensing and with all other local, state and national laws, and that no legal requirement has been or will be violated in making or accepting this proposal, in awarding the Contract to him, and/or in the prosecution of the Work required hereunder.
- F. To be considered a bona fide offer, this proposal must be completed in full and accompanied by a bid deposit or a bid bond when required by Contract Documents or Addenda.

1.06 ALTERNATES

- A. When alternate proposals are required by Contract Documents or Addenda thereto, the undersigned proposes to perform alternates for herein stated additions to or deductions from hereinbefore stated Base Bid. Additions and deductions include all modifications of Work or additional Work that the

undersigned may be required to perform by reason of the acceptance of alternates.

1.07 ALLOWANCE

- A. The allowance is intended to address items not able to be precisely determined prior to bidding including unforeseen conditions that are discovered during the course of construction. At the end of the project, unspent allowance shall be credited to owner via change order. See Section 01 21 00 – Allowances for additional information.

1.08 AGREEMENT

- A. In submitting this Bid, the undersigned agrees:
 - 1. To hold this Bid open for sixty (60) days from submittal date.
 - 2. To enter into and execute a Contract with the Owner within ten (10) days after receiving Notice of Award from the Owner.
 - 3. To accomplish the work in accordance with the Contract Documents.
 - 4. To complete the work by the time stipulated in the General Conditions
- B. The Owner reserves the right to reject any and all Bids and to waive any informalities in Bidding.

1.09 SCHEDULE

- A. See General Conditions for required schedule of completion dates.

1.10 PROPOSED PRICES

- A. The Bidder hereby proposes to furnish all labor, materials, equipment, transportation, construction plant and facilities necessary to complete, in a workmanlike manner and in accordance with the contract documents, the contract of work bid upon herein for compensation in accordance with the following prices:

BASE BID AMOUNT:	\$ _____
ALLOWANCE (ADDITIONAL WORK – GENERAL):	\$ _____ +5,000
TOTAL BASE BID AMOUNT:	\$ _____

1.11 BID SECURITY

If required by the bid documents, a scanned copy of the bid bond must be included with the bid electronic submission. The City is currently not able to accept a certified check, bank cashier's check or electronic bid bond at this time.

- A. The City of Evanston Civic Center is unable to receive in person drop-off and it

is closed to the public. The original bid bond must be mailed within ten (10) days after the due date, to the City of Evanston Purchasing Department, 2100 Ridge Avenue - Room 4200 Evanston, Illinois 60201 Attention Purchasing Manager using the USPS (certified or priority), UPS or FedEx mail options in order to have a tracking number.

- B. Accompanying this electronic submittal is a scanned copy of a bank draft, bid bond, Cashier's check or Certified check as surety in the amount of not less than five percent (5%) of the Total Bid payable to the City of Evanston.

The amount of the check or draft is: \$ _____

If this bid is accepted and the undersigned shall fail to execute a contract and contract bond as required it is hereby agreed that the amount of the check or draft or bidder's bond substituted in lieu thereof, shall become the property of the City and shall be considered as payment of damages due to delay and other causes suffered by the City because of the failure to execute said contract and contract bond; otherwise said check or draft shall be returned to the undersigned.

In the event that one check or draft is intended to cover two or more bids, the amount must be equal to the sum of the project proposal guarantees of the individual sections covered.

If the check or draft is placed on another project proposal, state below where it may be found, as follows: The check or draft will be found in the project proposal for: _____.

1.12 PERFORMANCE/PAYMENT BOND

The undersigned bidder agrees to provide Performance Bond and Payment Bond executed in accordance with Contract Performance Bond form furnished by and acceptable to the Owner written with _____

_____ in the amount of 100% of the Contract Sum (Total Base Bid and all accepted alternatives and adjustments) the cost of which is included in the Bid.

Cost of bond for change order is _____ percent of change order cost.

1.13 LIQUIDATED DAMAGES

The undersigned Bidder understands and agrees to the provisions stated under "LIQUIDATED DAMAGES" in the General Conditions and shall be assessed at the specified daily rate for each calendar day or partial calendar day until completion as defined herein.

1.14 MATERIAL SUBSTITUTION SHEET

The following is a schedule of substitute materials I propose to furnish on this job, with the difference in price being added to or deducted from the Base Bid. The Base Bid is understood to include only those items which are definitely specified by trade names or otherwise.

I understand that if no price difference is indicated, then the selection of materials is optional with the Owner, and approval or rejection of the substitution below will be indicated prior to signing of Contracts.

<u>PRODUCT NAME AND/OR MANUFACTURER</u>	<u>ADD</u>	<u>DEDUCT</u>
_____	_____	_____
_____	_____	_____
_____	_____	_____

1.15 PROPOSAL SIGNATURE (REQUIRED)

A. SOLE PROPRIETOR

Signature of Bidder: _____

SUBSCRIBED AND SWORN to before me this _____ day of _____, 20__

Notary Public

Commission Expires: _____

B. PARTNERSHIP

Signature of All Partners: _____

Name (typed or printed)

Name (typed or printed)

SUBSCRIBED AND SWORN to before me this _____ day of _____, 20__

Commission Expires: _____

Notary Public

C. CORPORATION

Signature of Authorized Official: _____

Title: _____

Name above (typed or printed): _____

(If other than the president, attach a certified copy of that section of corporate by-laws or other authorization by the Corporation which permits the person to execute the offer for the Corporation.)

(Corporate Seal)

Attest: _____
Secretary

SUBSCRIBED AND SWORN to before me this _____ day of _____, 20__

Commission Expires: _____

Notary Public

1.16 DISCLOSURE

- A. The undersigned duly sworn deposes and says on oath that the bidder has withheld no disclosures of ownership interest and the information provided herein to the best of its knowledge is current and said undersigned has not entered into any agreement with any other bidder or prospective bidder or with any other person, firm or corporation relating to the price named in said proposal or any other proposal, nor any agreement or arrangement under which any person, firm or corporation is to refrain from bidding, nor any agreement or arrangement for any act or omission in restraint of free competition among bidders and has not disclosed to any person, firm or corporation the terms of this bid or the price named herein.

Bidder: _____

Business Address: _____

Telephone Number: _____

1.17 CONTACTS

- A. In the event the Evanston City Council approves this bid response, list the name, address, telephone, and fax number of the person to be contacted:

Bidder: _____

Address: _____

Telephone Number: _____

Fax Number: _____

1.18 REFERENCES

A. Provide three (3) references for which your firm has completed work of a similar scope in the past.

1. Name: _____

Address: _____

Contact Person: _____

Phone: _____

Contract Value: _____

Contract Dates: _____

2. Name: _____

Address: _____

Contact Person: _____

Phone: _____

Contract Value: _____

Contract Dates: _____

3. Name: _____

Address: _____

Contact Person: _____

Phone: _____

Contract Value: _____

Contract Dates: _____

EXHIBIT B

City of Evanston M/W/EBE Policy

A City of Evanston goal is to provide contracting and sub-contracting opportunities to Minority Business Enterprises, Women Business Enterprises, and Evanston Business Enterprises. The goal of the Minority, Women and Evanston Business Enterprise Program (M/W/EBE) is to assist such businesses with opportunities to grow. To assist such growth, the City's goal is to have general contractors utilize M/W/EBEs to perform no less than 25% of the awarded contract.

Firms bidding on projects with the City must work to meet the 25% goal or request a waiver from participation. It is advised that bidders place advertisements requesting sub-contractors and that they email or contact individual firms that would be appropriate to partner in response to the project. For samples of possible advertisements, see the City of Evanston's Business Diversity Section <http://www.cityofevanston.org/business/business-diversity/> ([Sample Advertisement](#)). If you request a paper copy of the additional documents, it will be available free of charge from the Purchasing Office, 2100 Ridge Road Suite 4200, Evanston, IL 60201.

If a bidder is unable to meet the required M/W/EBE goal, the Bidder must seek a waiver or modification of the goal on the attached forms. Bidder must include:

1. A narrative describing the Bidder's efforts to secure M/W/EBE participation prior to the bid opening.
2. Documentation of each of the assist agencies that were contacted, the date and individual who was contacted, and the result of the conversation (see form)
3. A letter attesting to instances where the bidder has not received inquiries/proposals from qualified M/W/EBEs
4. Names of owners, addresses, telephone numbers, date and time and method of contact of qualified M/W/EBE who submitted a proposal but was not found acceptable.
5. Names of owners, addresses, telephone numbers, date and time of contact of at least 15 qualified M/W/EBEs the bidder solicited for proposals for work directly related to the Bid prior to the bid opening (copies must be attached).

If a bidder is selected with a Sub-contractor listed to meet the M/W/EBE goal, a "monthly utilization report" will be due to the City prior to each payment being issued to the Contractor. This report will include documentation of the name of the firm hired, the type of work that firm performed, etc. Should the M/W/EBE not be paid according to the schedule proposed in this document, the City reserves the right to cancel the contract. Examples of this monthly form can be found on the City's website:

<http://www.cityofevanston.org/business/business-diversity/> ([M/WEBE Monthly Utilization Report](#)).

EXHIBIT C

M/W/EBE PARTICIPATION COMPLIANCE FORM

I do hereby certify that

_____ (Name of firm) intends to participate as a Subcontractor or General Contractor on the project referenced above.

This firm is a (check only one):

_____ Minority Business Enterprise (MBE), a firm that is at least 51% managed and controlled by a minority, certified by a certifying agency within Illinois.

_____ Women's Business Enterprise (WBE), a firm that is at least 51% managed and controlled by a woman, certified by a certifying agency within Illinois.

_____ Evanston Based Enterprise (EBE), a firm located in Evanston for a minimum of one year and which performs a "commercially useful function".

Total proposed price of response \$ _____

Amount to be performed by a M/W/EBE \$ _____

Percentage of work to be performed by a M/W/EBE _____%

Information on the M/W/EBE Utilized:

Name _____

Address _____

Phone Number _____

Signature of firm attesting to participation _____

Title and Date _____

Type of work to be performed _____

Please attach:

1. Proper certification documentation if applying as a M/WBE and check the appropriate box below. This M/WBE will be applying with documentation from:

- Cook County State Certification
- Federal Certification Women's Business Enterprise National Council
- City of Chicago Chicago Minority Supplier Development Council

2. Attach business license if applying as an EBE

EXHIBIT C

M/W/EBE UTILIZATION SUMMARY REPORT

The following Schedule accurately reflects the value of each MBE/WBE/EBE sub-agreement, the amounts of money paid to each to date, and this Pay Request. The total proposed price of response submitted is _____.

MBE/WBE/EBE FIRM NAME	FIRM TYPE (MBE/WBE/ EBE)	SERVICES PERFORMED	AMOUNT OF SUB- CONTRACT	PERCENT OF TOTAL CONTRACT AMOUNT
			\$	
			\$	
			\$	
			\$	
			\$	
			\$	
			\$	
			\$	
			\$	
			\$	
			\$	
			\$	
			\$	
			\$	
			\$	
			\$	
			\$	
			\$	
			\$	
TOTAL			\$	

EXHIBIT D

M/W/EBE PARTICIPATION WAIVER REQUEST

I am _____ of _____, and I have authority to
(Title) (Name of Firm)

execute this certification on behalf of the firm. I _____ do
(Name)

hereby certify that this firm seeks to waive all or part of this M/W/EBE participation goal for the following reason(s):

(CHECK ALL THAT APPLY. SPECIFIC SUPPORTING DOCUMENTATION MUST BE ATTACHED.)

_____ 1. No M/W/EBEs responded to our invitation to bid.

_____ 2. An insufficient number of firms responded to our invitation to bid.

For #1 & 2, please provide a narrative describing the outreach efforts from your firm and proof of contacting at least 15 qualified M/W/EBEs prior to the bid opening. Also, please attach the accompanying form with notes regarding contacting the Assist Agencies.

_____ 3. No sub-contracting opportunities exist.

Please provide a written explanation of why sub-contracting is not feasible.

_____ 4. M/W/EBE participation is impracticable.

Please provide a written explanation of why M/W/EBE participation is impracticable.

Therefore, we request to waive _____ of the 25% utilization goal for a revised goal of _____%.

Signature: _____
(Signature)

Date: _____

EXHIBIT E

Construction Contractors' Assistance Organizations ("Assist Agencies") Form

AGENCY	DATE CONTACTED	CONTACT PERSON	RESULT OF CONVERSATION
Association of Asian Construction Enterprises (AACE) 5500 Touhy Ave., Unit K Skokie, IL. 60077 Phone: 847-5259693 Perry Nakachii, President			
Black Contractors United (BCU) 400 W. 76th Street Chicago, IL 60620 Phone: 773-483-4000; Fax: 773-483-4150 Email: bcunewera@ameritech.net			
Chicago Minority Business Development Council 105 West Adams Street Chicago, Illinois 60603 Phone: 312-755-8880; Fax: 312-755-8890 Email: info@chicagomsdc.org Shelia Hill, President			
Evanston Minority Business Consortium, Inc. P.O. Box 5683 Evanston, Illinois 60204 Phone: 847-492-0177 Email: embcinc@aol.com			
Federation of Women Contractors 5650 S. Archer Avenue Chicago, Illinois 60638 Phone: 312-360-1122; Fax: 312-360-0239 Email: FWCChicago@aol.com Contact Person: Beth Doria Maureen Jung, President			
Hispanic American Construction Industry (HACIA) 901 W. Jackson, Suite 205 Chicago, IL 60607 Phone: 312-666-5910; Fax: 312-666-5692 Email: info@haciaworks.org			
Women's Business Development Ctr. 8 S. Michigan Ave, Suite 400 Chicago, Illinois 60603 Phone: 312-853-3477 X220; Fax: 312-853-0145 Email: wbdc@wbdc.org Carol Dougal, Director			

PLEASE NOTE: Use of Construction Contractor's Assistance Organization (Assist Agencies") Form and agencies are for use as a resource only. The agencies and or vendors listed are not referrals or recommendations by the City of Evanston.

EXHIBIT F

CITY OF EVANSTON LOCAL EMPLOYMENT PROGRAM (LEP) COMPLIANCE

Effective Date January 1, 2015

City of Evanston Ordinance 60-O-14, Local Employment Program (LEP) New Penalties:

- **Ordinance 60-O-14**, Amendment to the MWEBE/LEP revising the penalty section from a \$100/per day to a 1.0% of total project value penalty can be found at: Ordinance 60-O-14 Amendment MWEBE LEP of the Evanston City Code Section 1-17-1 (C) can be found at Municode Library. The following are excerpts from Ordinance 60-O-14, Amending City Code Section 1-17-1(C) (11): Penalty.

If the contractor or sub-contractor fails to comply: The City may impose a fine up to one percent (1.0%) of the approved project price in total. Contractors or sub-contractors that are out of compliance due to a resident termination or resignation shall immediately notify the Business Workforce Compliance Coordinator of this occurrence within two (2) business days. Subsequently, the contractor or sub-contractor shall have five (5) additional business days to replace a terminated or resigned worker with another resident.

If the contractor or sub-contractor fails to comply: If the contractor or sub-contractor fails to make the replacement or to notify the Business Workforce Compliance Coordinator of this occurrence, the offending party will also be subject to a penalty up to one percent (1.0%) of the approved project price. If the noncompliant contractor makes a good faith effort to replace the resident, the fine may be waived.

If the contractor or sub-contractor fails to comply: At the sole discretion of the City, a contractor or sub-contractor that has violated the terms of the Local Employment Program within a three-year period may be determined a non-responsible bidder and excluded from bidding on future projects for a period of not less than one year.

If the employee (LEP Evanston resident) fails to comply: At the sole discretion of the City, an employee that has been hired through the LEP may be removed from the program for a period of not less than one year for failing to adhere to program guidelines or due to termination by the contractor for cause. Such termination process will be reviewed by the Business Workforce Compliance Coordinator.

****Detailed Local Employment Program Instructions “How to Comply” can be found at: [Local Employment Program Detailed Instructions](#)**

Local Employment Program or Exhibit F Questions: City staff is available for assistance to help with compliance. Submit questions in writing to Tammi Nunez, Purchasing Manager at tnunez@cityofevanston.org.

EXHIBIT F
LOCAL EMPLOYMENT PROGRAM COMPLIANCE
CITY CODE SECTION 1-17-1(C): LOCAL EMPLOYMENT PROGRAM

I have read and understood the requirements of the City of Evanston Local Employment Program (“LEP”) as set forth in City of Evanston Code Section 1-17-1(C): Local Employment Program. I intend to comply with the program as follows:

Estimated total labor cost = \$ _____ 15% of total labor cost = \$ _____

- _____ My total bid, including all alternates, is under \$250,000, and the LEP does not apply.
- _____ My total bid, including all alternates, is equal to or greater than \$250,000, and I already employ, and will continue to employ for the duration of the contract for which I am submitting this bid, Evanston residents (residing in zip codes 60201 or 60202) for at least 15% of all hours worked at the construction site by construction trade workers.
- _____ My total bid, including all alternates, is equal to or greater than \$250,000, and I will employ, for the duration of the contract for which I am submitting this bid, through use of the City of Evanston database or otherwise, Evanston residents (residing in zip codes 60201 or 60202) for at least 15% of all hours worked at the construction site by construction trade workers.
- _____ My total bid, including all alternates, is equal to or greater than \$250,000, and I have been unable to comply with the LEP requirements but am willing to work with the City to achieve compliance.
- _____ My total bid, including all alternates, is equal to or greater than \$250,000, and after having made sincere attempt to comply as noted below, I seek a waiver on a portion or all of the LEP requirements on this contract. Complete next section “Reasons for Waiver Request” below.

I UNDERSTAND THAT FAILURE TO COMPLY WITH THE LEP, REGARDLESS OF INTENT, MAY RESULT IN MAXIMUM PENALTY AS SET FORTH IN CITY CODE SECTION 1-17-1(C)(11), AS AMENDED.

WAIVER WILL BE GRANTED ONLY AFTER SINCERE ATTEMPT TO COMPLY*

REASONS FOR WAIVER REQUEST: PLEASE CHECK ALL THAT APPLY AND COMPLETE INFORMATION REQUESTED:

1. I have made sincere attempt as otherwise indicated below, but have nonetheless been unable to comply.
 - a. I do or will employ Evanston residents for the project, but such employment amounts to _____% of total labor cost.
2. The nature of the job is so technical that after having made sincere attempt as otherwise indicated below, I have been unable to locate any Evanston residents qualified to perform any aspects of the work. Please describe applicable job requirements/qualifications. Attach separate sheet if necessary:

*THE FOLLOWING DEMONSTRATE **SINCERE ATTEMPT TO COMPLY**: PLEASE CHECK EACH BOX COMPLETED, AS APPLICABLE:

3. I have utilized the local resident database and otherwise worked with the City in attempt to hire Evanston residents in compliance with LEP on this project, and have nonetheless been unable to comply;
4. I have placed one or more ads in a local newspaper seeking to hire Evanston residents in compliance with LEP on this project, and have nonetheless been unable to comply; and
5. If I am utilizing union labor, I have contacted Chicagoland labor unions to request Evanston residents for employment in compliance with LEP on this project, and have nonetheless been unable to comply.

I have read The City of Evanston, Local Employment Program (LEP) requirements as set forth in City Code Section 1-17-1(C): Local Employment Program. I understand and will comply with the LEP requirements for this project with respect to the job and/or any waiver, as applicable. **I UNDERSTAND THAT IF MY APPLICATION IS NOT COMPLETE, MY BID MUST BE REJECTED.**

SIGNED:

Signature

Printed Name and Title

Date

On behalf of Company: _____

EXHIBIT F

EXHIBIT G

**CERTIFICATION OF BIDDER REGARDING
EQUAL EMPLOYMENT OPPORTUNITY
(Only if Contract Exceeds \$10,000)**

This certification is required pursuant to Executive Order 11246 (30 F.R. 12319-25). The implementing rules and regulations provide that any bidder or prospective contractor, or any of their proposed sub-contractors, shall state as an initial part of the bid or negotiations of the contract whether it has participated in any previous contract or sub-contract subject to the equal opportunity clause; and, if so, whether it has filed all compliance reports due under applicable instructions.

Where the certification indicates that the bidder has not filed a compliance report due under applicable instructions, such bidder shall be required to submit a compliance report within seven calendar days after bid opening. No contract shall be awarded unless such report is submitted.

CERTIFICATION OF BIDDER

Name and Address of Bidder (Include ZIP Code)

IRS EMPLOYER I.D. NUMBER 36-_____

1. Bidder has participated in a previous contract or sub-contract subject to the Equal Opportunity Clause. Yes No
2. Bidder has filed all compliance reports due under applicable instructions. Yes No
3. Have you ever been or are you being considered for sanction due to violation of Executive Order 11246, as amended? Yes No

Name: _____

Title: _____

Signature: _____

Date: _____

EXHIBIT H

DISCLOSURE OF OWNERSHIP INTERESTS

City of Evanston Ordinance 15-0-78 requires all persons (APPLICANT) seeking to do business with the City to provide the following information with their bid. Every question must be answered. If the question is not applicable, answer with "NA".

APPLICANT NAME: _____

APPLICANT ADDRESS: _____

TELEPHONE NUMBER: _____

FAX NUMBER: _____

APPLICANT is (**Check One**)

- 1. Corporation () 2. Partnership () 3. Sole Owner () 4. Association ()
- 5. Other () _____

Please answer the following questions on a separate attached sheet if necessary.

SECTION I - CORPORATION

1a. Names and addresses of all Officers and Directors of Corporation.

1b. (Answer only if corporation has 33 or more shareholders.) Names and addresses of all those shareholders owning shares equal to or in excess of 3% of the proportionate ownership interest and the percentage of shareholder interest. (Note: Corporations which submit S.E.C. form 10K may substitute that statement for the material required herein.)

1c. (Answer only if corporation has fewer than 33 shareholders.) Names and addresses of all shareholders and percentage of interest of each herein. (Note: Corporations which submit S.E.C. form 10K may substitute that statement for the material requested herein.)

SECTION 2 - PARTNERSHIP/ASSOCIATION/JOINT VENTURE

2a. The name, address, and percentage of interest of each partner whose interests therein, whether limited or general is equal to or in excess of 3%.

2b. Associations: The name and address of all officers, directors, and other members with 3% or greater interest.

SECTION 3 - TRUSTS

3a. Trust number and institution.

3b. Name and address of trustee or estate administrator.

3c. Trust or estate beneficiaries: Name, address, and percentage of interest in total entity.

SECTION 4 - ALL APPLICANTS - ADDITIONAL DISCLOSURE

4a. Specify which, if any, interests disclosed in Section 1, 2, or 3 are being held by an agent or nominee, and give the name and address of principal.

4b. If any interest named in Section 1, 2, or 3 is being held by a "holding" corporation or other "holding" entity not an individual, state the names and addresses of all parties holding more than a 3% interest in that "holding" corporation or entity as required in 1(a), 1(b), 1(c), 2(a), and 2(b).

4c. If "constructive control" of any interest named in Sections 1, 2, 3, or 4 is held by another party, give name and address of party with constructive control. ("Constructive control" refers to control established through voting trusts, proxies, or special terms of venture of partnership agreements.)

I have not withheld disclosure of any interest known to me. Information provided is accurate and current.

Date

Signature of Person Preparing Statement

Title

ATTEST: _____
Notary Public

(Notary Seal)

Commission Expires: _____

EXHIBIT I

ADDITIONAL INFORMATION SHEET

Bid/Proposal Name: _____

Bid/Proposal Number #: _____

Company Name: _____

Contact Name: _____

Address: _____

City, State, Zip: _____

Telephone/FAX: # _____

E-mail: _____

Comments: _____

EXHIBIT J

**CERTIFICATE OF COMPLIANCE
WITH PREVAILING WAGE RATE ACT**

The undersigned, upon being first duly sworn, hereby certifies to the City of Evanston, Cook, County, Illinois, that all work under this contract shall comply with the Prevailing Wage Rate Act of the State of Illinois, 820 ILCS 130 *et seq*, and as amended by Public Acts 86-799 and 86-693 and current City of Evanston Resolution, with rates to be paid in effect at time work is performed. Contractors shall submit monthly certified payroll records to the city.

Name of Contractor: _____

By: _____

By: State of _____, County of _____

Subscribed and sworn to before me this _____ day
of _____, _____.

Notary Public

EXHIBIT K

MAJOR SUB-CONTRACTORS LISTING

The following Tabulation of Major Sub-contractors shall be attached and made a condition of the Bid. The Bidder expressly understands and agrees to the following provisions:

- A. If awarded a Contract as a result of this Bid, the major sub-contractors used in the prosecution of the work will be those listed below.
- B. The following list includes all sub-contractors who will perform work representing 5% (five percent) or more of the total Base Bid.
- C. The sub-contractors listed below are financially responsible and are qualified to perform the work required.
- D. The sub-contractors listed below comply with the requirements of the Contract Documents.
- E. Any substitutions in the sub-contractors listed below shall be requested in writing by the Contractor and must be approved in writing by the Owner. All pertinent financial, performance, insurance and other applicable information shall be submitted with the request for substitutions(s). Owner shall respond to such requests within 14 calendar days following the submission of all necessary information to the full satisfaction of the Owner.

<u>Category</u>	<u>Name of Sub-contractor</u>	<u>Address and Phone Number</u>

(Attach additional sheets as required)

END OF SECTION

EXHIBIT L

CONFLICT OF INTEREST

_____, hereby certifies that it has conducted an investigation into whether an actual or potential conflict of interest exists between the Bidder, its owners and employees and any official or employee of the City of Evanston.

Bidder further certifies that it has disclosed any such actual or potential conflict of interest and acknowledges if Bidder/proposer has not disclosed any actual or potential conflict of interest, the City of Evanston may disqualify the bid/proposal.

(Name of Bidder/proposer if the Bidder/proposer is an Individual)
(Name of Partner if the Bidder/proposer is a Partnership)
(Name of Officer if the Bidder/proposer is a Corporation)

The above statements must be subscribed and sworn to before a notary public.
Subscribed and Sworn to this _____ day of _____, 20

Notary Public

(Notary Seal)

Commission Expires: _____

EXHIBIT M

SIGNATURE FORM

THE SECTION BELOW MUST BE COMPLETED IN FULL AND SIGNED

The undersigned hereby certifies that they have read and understand the contents of this solicitation and attached service agreements, and agree to furnish at the prices shown any or all of the items above, subject to all instructions, conditions, specifications and attachments hereto. Failure to have read all the provisions of this solicitation shall not be cause to alter any resulting contract or to accept any request for additional compensation. By signing this document, the proposer hereby certifies that they are not barred from bidding on this contract as a result bid rigging or bid rotating or any similar offense (720 ILCS 5/33 E-3, E-4).

Authorized Signature: _____

Company Name: _____

Typed/Printed Name: _____

Date: _____

Title: _____

Telephone Number: _____

E-mail _____

Fax Number: _____

Exhibit N

Contractor Services Agreement Acknowledgement Page

The City has attached its standard contractor services agreement as an exhibit to this bid document. Identify all exceptions to the agreement that would prevent your firm from executing it. **The City shall not consider or negotiate regarding exceptions submitted at any time after the submission of the Bidder's response.** *Please check one of the following statements:*

____ I have read the contractor services agreement and plan on executing the agreement without any exceptions.

_____ My firm cannot execute the City's standard contractor service agreement unless the exceptions noted below or in the attached sample contractor services agreement are made.

*****Please be aware that submitting exceptions to the contract may impact the likelihood of your firm being selected to perform this work.**

List exceptions in the area below:

**Authorized
Signature:** _____

**Company
Name:** _____

**Typed/Printed
Name and Title:** _____

Date: _____

Exhibit N

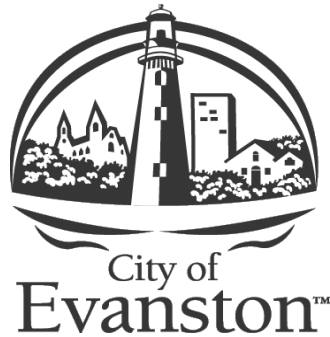

CONTRACTOR SERVICES AGREEMENT

The parties referenced herein desire to enter into an agreement for professional services for

*Robert Crown Community Center
Gymnasium Acoustic Panel Installation
(BID #23-22)*

THIS AGREEMENT (hereinafter referred to as the “Agreement”) is entered into between the City of Evanston, an Illinois municipal corporation with offices located at 2100 Ridge Avenue, Evanston Illinois 60201 (hereinafter referred to as the “City”), and *[Insert Contractor name here]*, with offices located at *[Insert Contractor address here]*, (hereinafter referred to as the “Contractor”). Compensation (the “Compensation”) for all basic services provided by the Contractor pursuant to the terms of this Agreement shall not exceed *[\$[Insert fee here]]*.

Revision March 2020

TABLE OF CONTENTS

1	Services and Duties of the Contractor.....	1
2	Standard Certifications.....	4
3	Additional Services/Change Orders.....	7
4	Bonds	9
5	Liquidated Damages in the Event Contractor Fails to Complete the Work.....	10
6	The City’s Responsibilities	10
7	Period of Service.....	10
8	Payment for Services and Reimbursements	11
9	Notice and Cure/Termination	12
10	Insurance	13
11	Indemnification	14
12	Drawings and Documents	15
13	Successors and Assigns.....	16
14	Force Majeure	16
15	Amendments and Modifications.....	17
16	Standard of Care & Warranty	17
17	Savings Clause	18
18	Non-Waiver of Rights.....	18
19	Entire Agreement	19
20	Governing Law	19
21	Ownership of Contract Documents.....	19
22	Notice.....	19
23	Severability	20
24	Execution of Agreement	20
25	Counterparts	20
26	Authorizations.....	20
27	Time of Essence.....	20

RECITALS

WHEREAS, the City intends to retain the services of a qualified and experienced contractor for the following:

Install Owner provided acoustic panels in the Robert Crown Center's gymnasium as shown in the bid document.

WHEREAS, this Agreement shall include the following documents which are attached hereto:

- a) City of Evanston Bid 23-22, attached as Exhibit A.
- b) Contractor's response to Bid 23-22, attached as Exhibit B.
- c) Any sub-contractor sub-contracts related to this Agreement, attached as Exhibit C.
- d) Project Fee Schedule and hourly rates, attached as Exhibit D (*if appropriate*).

NOW, THEREFORE, in consideration of the mutual covenants hereinafter set forth, the parties agree as follows:

1 Services and Duties of the Contractor

1.1 The Contractor shall perform professional services and provide equipment (the "Work") in accordance with Exhibits A, B, C and D. The Contractor retains the right to control the manner of performance of the services provided for in this Agreement and is an independent contractor and not agent or an employee of the City. All employees and sub-contractors of the Contractor shall likewise not be considered to be employees of the City. Contractor is solely responsible for the means and methods of all work performed under the terms of this Agreement for this Project ("the Project"). Contractor is an independent Contractor and is solely responsible for all taxes, withholdings, and other statutory or contractual obligations of any sort, including but not limited to, Worker's Compensation Insurance. Nothing in this Agreement accords any third-party beneficiary rights whatsoever to any non-party to this Agreement that any non-party may seek to enforce. Contractor acknowledges and agrees that should Contractor or its sub-contractors provide false information, or fail to be or remain in compliance with this Agreement; the City may void this Agreement.

1.2 The Contractor warrants and states that it has read the Contract Documents, and agrees to be bound thereby, including all performance guarantees as respects Contractor's work and all indemnity and insurance requirements. Contractor further affirms that it has visited the Project site and has become familiar with all special conditions, if any, at the Project site. Contractor shall perform the Work and its obligations under this Agreement in accordance with and subject to the Contract Documents to the full extent that each such provision is applicable to the Work. Contractor shall take necessary precautions to properly protect the Work of others, if any, from damage caused by operations under this Agreement. In addition, Contractor shall protect the work during normal and adverse weather conditions until the Project is complete and accepted by the City, or until the

EXHIBIT N

Contractor has fully completed its work under this Agreement. Contractor's obligations include, but are not limited to, placing and adequately maintaining at or about all locations of Project work, sufficient guards, barricades, lights, and enclosures to protect the Work.

1.3 The Contractor shall not have any public or private interest and shall not acquire directly or indirectly any such interest which conflicts in any manner with the performance of its services under this Agreement.

1.4 The Contractor shall designate, in writing, a person to act as its Project Manager for the work to be performed under this Agreement. Such person shall have complete authority to transmit instructions, receive information, interpret and define the Contractor's policies and decisions with respect to the work covered by this Agreement.

1.5 The Contractor shall employ only persons duly licensed by the State of Illinois to perform the professional services required under this Agreement for which applicable Illinois law requires a license, subject to prior approval of the City. The Contractor shall employ only well qualified persons to perform any of the remaining services required under this Agreement, also subject to prior approval of the City. The City reserves the right to require replacement of Contractor, sub-contractor, or supplier personnel for any reason. Contractor will replace the unacceptable personnel at no charge to the City. For all solicitations or advertisements placed by or on behalf of Contractor for employees for this Project it will state that the Contractor is an Equal Opportunity Employer.

1.6 Pursuant to the Illinois Freedom of Information Act, 5 ILCS 140/7(2), records in the possession of others whom the City has contracted with to perform a governmental function are covered by the Act and subject to disclosure within limited statutory timeframes (five (5) working days with a possible five (5) working day extension). Upon notification from the City that it has received a Freedom of Information Act request that calls for records within the Contractor's control, the Contractor shall promptly provide all requested records to the City so that the City may comply with the request within the required timeframe. The City and the Contractor shall cooperate to determine what records are subject to such a request and whether or not any exemption to the disclosure of such records, or part thereof, is applicable. Contractor shall indemnify and defend the City from and against all claims arising from the City's exceptions to disclosing certain records which Contractor may designate as proprietary or confidential. Compliance by the City with an opinion or a directive from the Illinois Public Access Counselor or the Attorney General under FOIA, or with a decision or order of Court with jurisdiction over the City, shall not be a violation of this Section.

1.7 The Contractor shall obtain prior approval from the City prior to sub-contracting with any entity or person to perform any of the work required under this Agreement. The Contractor may, upon request of the City, submit to the City a draft sub-contractor agreement for City review and approval prior to the execution of such an agreement. Any previously entered into sub-contractor agreement(s) are attached as Exhibit C. If the Contractor sub-contracts any of the services to be performed under this Agreement, the sub-contractor agreement shall provide that the services to be performed under any such agreement shall not be sublet, sold, transferred, assigned or otherwise

disposed of to another entity or person without the City's prior written consent. The Contractor shall be responsible for the accuracy and quality of any sub-contractor's work.

1.8 The Contractor shall cooperate fully with the City, other City contractors, other municipalities and local government officials, public utility companies, and others, as may be directed by the City. This shall include attendance at meetings, discussions and hearings as requested by the City. This cooperation shall extend to any investigation, hearings or meetings convened or instituted by OSHA relative to this Project, as necessary. Contractor shall cooperate with the City in scheduling and performing its Work to avoid conflict, delay in or interference with the work of others, if any, at the Project.

1.9 The Contractor acknowledges that it shall enforce and comply with all applicable Occupational Safety and Health Administration standards (OSHA) for this Project in effect as of the date of the execution of this Agreement, or as otherwise promulgated by OSHA in the future taking effect during the pendency of this Project. Contractor shall enforce all such standards and ensure compliance thereto as to its own agents and employees, and as to the agents and employees of any sub-contractor throughout the course of this Project. Contractor is solely responsible for enforcing and complying with all applicable safety standards and requirements on this Project, and is solely responsible for correcting any practices or procedures which do not comply with the applicable safety standards and requirements for this Project. Any Project specific safety requirements applicable to this Project must be followed by Contractor and any sub-contractor(s) on the Project. Additionally, all such safety requirements shall be made a part of any sub-contractor agreement.

1.10 The Contractor shall submit to the City a progress report each month this Agreement is in effect. The report shall include the following items:

- a) A summary of the Contractor's project activities, and any sub-contractor project activities that have taken place during the invoice period;
- b) A summary of the Contractor's project activities and any sub-contractor project activities, that shall take place during the next invoice period;
- c) A list of outstanding items due to or from the City; and
- d) A status of the Project schedule.

1.11 The Contractor shall perform the work required under this Agreement pursuant to high quality industry standards expected by the City. The Contractor shall apply for and receive all appropriate permits before performing any work in the City. The Contractor shall also provide the appropriate permit drawings for Building Permits to be issued for the Project, if said permits are obligated by the Project. The City will assist the Contractor with obtaining the appropriate building and right-of-way permits.

1.12 The Contractor shall provide drawings of record, in the following 3 electronic formats for all locations where equipment has been installed and/or work has been performed. The electronic formats required by this Section 1.12 are Auto Cad Version 2007, ArcView and PDF.

1.13 Contractor recognizes that proper cleanup and removal of construction debris is an important safety consideration. The Contractor shall be solely responsible for daily construction site/area cleanup and removal of all construction debris in accordance with City-approved disposal practices. Contractor shall be solely responsible for identifying and removing at its expense all hazardous material and waste which it uses and generates.

1.14 To the extent that there is any conflict between a provision specified in this Agreement, with a provision specified in any of the other Contract Documents, as defined in Section 1.15, this Agreement shall control. The City and the Contractor may amend this Section 1.14 as provided by Section 15 herein.

The Contractor acknowledges and agrees that the City has no retained control over any of the Work done pursuant to this Agreement, and that the City is expressly exempt from the retained control exception as defined in the Restatement of Torts, Second, Section 414. This provision shall survive completion, expiration, or termination of this Agreement.

1.15 The Contract Documents for this Project consist of:

- a) This Agreement;
- b) The City's RFP/RFQ, and the plans, specifications, general conditions, drawings addenda, and modifications thereto;
- c) The Contractor's response to the RFP/RFQ/Bid;
- d) Other exhibits and schedules, if any, listed in this Agreement;
- e) Amendments or Other Contract Documents, if any; and
- f) Amendments/Modifications to this Agreement issued after execution thereof.

1.16 As a condition of receiving payment, Contractor must (i) be in compliance with the Agreement, (ii) pay its employees prevailing wages when required by law (Examples of prevailing wage categories include public works, printing, janitorial, window washing, building and grounds services, site technician services, natural resource services, security guard and food services). Contractor is responsible for contacting the Illinois Dept. of Labor 217-782-6206; <http://www.illinois.gov/idol/Laws-Rules/CONMED/Pages/Rates.aspx> to ensure compliance with prevailing wage requirements), (iii) pay its suppliers and sub-contractors according to the terms of their respective contracts, and (iv) provide lien waivers to the City upon request.

2 Standard Certifications

Contractor acknowledges and agrees that compliance with this section and each subsection for the term of the Agreement is a material requirement and condition of this Agreement. By executing this Agreement, Contractor certifies compliance with this section and each subsection and is under a continuing obligation to remain in compliance and report any non-compliance.

This section, and each subsection, applies to sub-contractors used on this Agreement. Contractor shall include these Standard Certifications in any sub-contract used in the performance of the Agreement.

If this Agreement extends over multiple fiscal years, Contractor and its sub-contractors shall confirm compliance with this section in the manner and format determined by the City by the date specified by the City and in no event later than January 1 of each year that this Agreement remains in effect.

If the City determines that any certification in this section is not applicable to this Agreement, it may be stricken, subject to sole approval by the City, without affecting the remaining subsections.

2.1 As part of each certification, Contractor acknowledges and agrees that should Contractor or its sub-contractors provide false information, or fail to be or remain in compliance with the Standard Certification requirements, one or more of the following sanctions will apply:

- the Agreement may be void by operation of law,
- the City may void the Agreement, and
- Contractor and its sub-contractors may be subject to one or more of the following: suspension, debarment, denial of payment, civil fine, or criminal penalty.

2.2 By signing this Agreement, the Contractor certifies that it has not been barred from being awarded a contract with a unit of State or local Government as a result of bid rigging or bid rotating or similar offense, nor has it made any admission of guilt of such conduct that is a matter of public record. (720 ILCS 5/33 E-3, E-4).

2.3 In the event of the Contractor's noncompliance with any provision of Section 1-12-5 of the Evanston City Code, the Illinois Human Rights Act or any other applicable law, the Consultant may be declared non-responsible and therefore ineligible for future contracts or sub-contracts with the City, and the contract may be cancelled or voided in whole or in part, and such other sanctions or penalties may be imposed or remedies invoked as provided by statute or regulation.

2.4 During the term of this Agreement, the Contractor agrees as follows:

- a) That it will not discriminate against any employee or applicant for employment because of race, color, religion, sex, sexual orientation, marital status, national origin or ancestry, or age or physical or mental disabilities that do not impair ability to work, and further that it will examine all job classifications to determine if minority persons or women are underutilized and will take appropriate affirmative action to rectify any such underutilization. Consultant shall comply with all requirements of City of Evanston Code Section 1-12-5.
- b) That, in all solicitations or advertisements for employees placed by it on its behalf, it will state that all applicants will be afforded equal opportunity without discrimination because of race, color, religion, sex, sexual orientation, marital status, national origin, ancestry, or disability.

2.5 The Contractor certifies pursuant to the Illinois Human Rights Act (775 ILCS 5/2105

et. seq.), that it has a written sexual harassment policy that includes, at a minimum, the following information:

- a) The illegality of sexual harassment;
- b) The definition of sexual harassment under State law;
- c) A description of sexual harassment utilizing examples;
- d) The Contractor's internal complaint process including penalties;
- e) Legal recourse, investigation and complaint process available through the Illinois Department of Human Rights and the Human Rights Commission, and directions on how to contact both; and
- f) Protection against retaliation as provided to the Department of Human Rights.

2.6 In accordance with the Steel Products Procurement Act (30 ILCS 565), Contractor certifies steel products used or supplied in the performance of a contract for public works shall be manufactured or produced in the U.S. unless the City grants an exemption.

2.7 Contractor certifies that it is properly formed and existing legal entity and as applicable has obtained an assumed name certificate from the appropriate authority, or has registered to conduct business in Illinois and is in good standing with the Illinois Secretary of State.

2.8 If Contractor, or any officer, director, partner, or other managerial agent of Contractor, has been convicted of a felony under the Sarbanes-Oxley Act of 2002, or a Class 3 or Class 2 felony under the Illinois Securities Law of 1953, Contractor certifies at least five years have passed since the date of the conviction.

2.9 Contractor certifies that if more favorable terms are granted by Contractor to any similar governmental entity in any state in a contemporaneous agreement let under the same or similar financial terms and circumstances for comparable supplies or services, the more favorable terms will be applicable under this Agreement.

2.10 Contractor certifies that it is not delinquent in the payment of any fees, fines, damages, or debts to the City of Evanston.

2.11 The Contractor certifies that all Design Professionals performing the Work under this Agreement will ensure that the Project shall be designed in conformance with the Americans with Disabilities Act of 1990, 42 U.S.C. Section 12101, *et seq.*, and all regulations promulgated thereunder. Design Professional means any individual, sole proprietorship, firm, partnership, joint venture, corporation, professional corporation, or other entity that offers services under the Illinois Architecture Practice Act of 1989 (225 ILCS 305/), the Professional Engineering Practice Act of 1989 (225 ILCS 325/), the Structural Engineering Licensing Act of 1989 (225 ILCS 340/), or the Illinois Professional Land Surveyor Act of 1989 (225 ILCS 330/).

2.12 The Contractor shall comply with all federal, state and local laws, statutes, ordinances, rules, regulations, orders or other legal requirements now in force or which may be in force during the term of this Agreement. The Contractor shall comply with the Illinois Human Rights

EXHIBIT N

Act, 775 ILCS 5/1-101 *et. seq.*, Title VII of the Civil Rights Act of 1964, and the Illinois Prevailing Wage Act, 820 ILCS 130/0.01 *et. seq.*

3 Additional Services/Change Orders

3.1 If the representative of the City responsible for the Project verbally requests the Contractor to perform additional services, the Contractor shall confirm in writing that the services have been requested and that such services are additional services. Failure of the City to respond to the Contractor's confirmation of said services within thirty (30) calendar days of receipt of the notice shall be deemed a rejection of, and refusal to pay for the additional services. Contractor shall not perform any additional services until City has confirmed approval of said additional services in writing. If authorized in writing by the City, the Contractor shall furnish, or obtain from others, additional services of the following types, which shall be paid for by the City as set forth in Section 9 of this Agreement:

- a) Additional Services due to significant changes in scope of the Project or its design, including, but not limited to, changes in size, complexity or character of construction, or time delays for completion of work when such delays are beyond the control of the Contractor;
- b) Revisions of previously approved studies, reports, design documents, drawings or specifications;
- c) Preparation of detailed renderings, exhibits or scale models for the Project;
- d) Investigations involving detailed consideration of operations, maintenance and overhead expenses for the preparation of rate schedules, earnings and expense statements, feasibility studies, appraisals and valuations, detailed quantity surveys of material and labor, and material audits or inventories required for certification of force account construction performed by the City;
- e) Services not otherwise provided for in this Agreement.

3.2 The City may, upon written notice, and without invalidating this Agreement, require changes resulting in the revision or abandonment of work already performed by the Contractor, or require other elements of the work not originally contemplated and for which full compensation is not provided in any portion of this Agreement. Any additional services, abandonment of services which were authorized by the City, or changes in services directed by the City which result in the revision of the scope of services provided for in Exhibits A, B, C, and D that cause the total Compensation due Contractor under this Agreement to exceed \$25,000 or more, or increase or decrease the contract duration by more than 30 days are subject to approval by the Evanston City Council. These actions must be addressed either in a written Change Order or in a written amendment to this Agreement approved by both parties.

3.3 Contractor acknowledges and agrees that the Public Works Construction Change Order Act, 50 ILCS 525/1 *et seq.* shall apply to all Change Orders for the Project. It is expressly understood and agreed to by Contractor that it shall not be entitled to any damages or Compensation from the City on account of delay or suspension of all or any part of the Work. Contractor acknowledges that delays are inherent in construction projects and Contractor assessed that risk and

fully included that risk assessment within its contract sum specified in its Response to the City Bid for this Project. The City shall not compensate Contractor for work that is more difficult than the contract sum specified in its Response would reflect. Delays to minor portions of the Work will not be eligible for extensions of time.

Delays to the Project caused by labor disputes or strikes involving trades not directly related to the Project, or involving trades not affecting the Project as a whole will not be eligible for an extension of time.

The City will not grant an extension of time for a delay by the Contractor's inability to obtain materials unless the Contractor first furnishes to the City documentary proof. The proof must be provided in a timely manner in accordance with the sequence of the Contractor's operations and accepted construction schedule.

In addition to any other changes requested by City (as described in Sections 3.1 and 3.2), the Company shall be entitled to request (and the City may grant) Change Orders with respect to:

- (a) The City-caused delays;
- (b) Change in Law;
- (c) Force Majeure Events.

The foregoing events shall entitle the Contractor to a change in the Compensation for this Project, if the Contractor demonstrates that it will unavoidably incur reasonable costs as a result thereof and the Contractor provides reasonable and detailed documentary support with respect to any such price impact.

The parties agree to reasonably confer regarding any such disputes with respect to the issuance of a Change Order.

Any payment for compensable delay will only be based upon actual costs excluding, without limitation, what damages, if any, the Contractor may have reasonably avoided. The Contractor understands that this is the sole basis for recovering delay damages and explicitly waives any right to calculate daily damages for office overhead, profit, or other purported loss.

All Contractor Change Orders authorized under this Section 3 shall be made in writing. In remitting a Change Order, the Contractor must first show in writing that:

- (a) The work was outside the scope of this Agreement,
- (b) The extra work was not made necessary due to any fault of Contractor;
- (c) The circumstances said to necessitate the change in performance were not reasonably foreseeable at the time the Agreement was signed;
- (d) The change is germane to the original Agreement; and
- (e) The Change Order is in the best interest of the City and authorized by law.

Any person who fails to first obtain the City's written authorization for a Change Order commits a Class 4 felony. The written determination and the written Change Order resulting from that determination shall be preserved in the contract's file which shall be open to the public for inspection.

The City reserves all rights and causes of action, at law or equity, to seek redress against entities or persons who violate the requirements of this Section 3. By initialing below, Contractor hereby acknowledges that it is bound by this Section 3.

Contractor's Initials: _____

3.4 The Contractor is required to include the City of Evanston as a reference whenever and wherever the Contractor provides references for similar projects for a period of one (1) year from the date of Final Acceptance by the City of the Work for this Project.

4 Bonds

4.1 Before the Scheduled Construction Commencement Date, the Contractor is required to furnish unconditional performance and payment bonds in the amount of 100% of the Compensation as security for the faithful performance and completion of all the Contractor's obligations under the Contract Documents and covering the payment of all materials used in the performance of this Agreement and for all labor and services performed under this Agreement. All Bonds shall be issued on a form acceptable to the City. The bonds must be for the entire term of the Agreement. Failure to provide these bonds shall constitute a breach of Contractor's obligations under this Agreement. Each surety providing the Bonds must have a Best's rating not less than A/X and be licensed in Illinois and shall be named in the current list of "Companies Holding Certificates of Authority as Acceptable Sureties on Federal Bonds and as Acceptable Reinsuring Companies" as published in Circular 570 as published in the Federal Register and available on the website of the U.S. Department of the Treasury, Financial Management Service, at www.fms.treas.gov/c570/c570.html. All Bonds signed by an agent must be accompanied by a certified copy of his or her authority to act. It shall be the duty of the Contractor to advise the surety or sureties of any Change Orders that result in an increase to the Compensation and to ensure that the amounts of the Bonds are updated to reflect and cover any such increases throughout the course of the Project. The cost of such Bonds shall be included within the Compensation.

4.2 If the surety behind any Bond furnished by the Contractor is declared bankrupt or becomes insolvent or its right to do business is terminated in the State or it ceases to meet any of the requirements of this Contract, the Contractor shall, within [5] five days thereafter, substitute another Bond of equivalent value and surety, both of which must be acceptable to the City. In addition, no further progress payments under the Agreement will be made by the City until the Contractor complies with the provisions of this Agreement. The Contractor shall furnish to the City proof of any required bonds and proof of required insurance as one of the conditions precedent to payment under the Agreement. Upon the request of any person or entity appearing to be a potential beneficiary of bonds covering payment or performance of obligations arising under the Contract, the Contractor shall promptly furnish a copy of the bonds or authorize a copy to be furnished. All surety Bonds

provided for in this Section shall incorporate by reference this Agreement, and any language that may be in any such surety Bond which conflicts with the provisions of this Agreement that define the scope of the surety('s) duty(ies) shall be of no force and effect.

5 Liquidated Damages in the Event Contractor Fails to Complete the Work

5.1 The parties agree that failure of Contractor to timely complete the Work required by this Agreement constitutes a default. The parties agree that this default will result in damage and injury to City. The parties further agree, however, that actual damages incurred by City as result of such default is difficult if not impossible to ascertain with any degree of certainty or accuracy. Accordingly, the parties have negotiated and have agreed that for each calendar day after written notice is delivered to Contractor and Contractor fails to cure such default, that Contractor will pay City, as and for liquidated damages, and not as a penalty, a sum in the amount as specified in Section 108.09 of the IDOT Standard Specifications per calendar day. Contractor shall reimburse the City for all costs, expenses and fees (including, without limitation, attorneys' fees), if any, paid by the City in connection with such written demand by City. Contractor stipulates and agrees that the sums payable by Contractor under this Section are reasonable under the circumstances existing as of the execution of this Agreement. This Section 5.1 is not intended to limit any direct damages that may be recoverable by City related to the Contractor's failure to complete the Work in accordance with this Agreement. There shall be no early completion bonus if the Work is completed before the contract's deadlines. The City, at its option, may withhold liquidated damages from progress payments payable to Contractor before project completion.

6 The City's Responsibilities

6.1 The City may evaluate the Contractor's and any sub-contractor's performance (interim and final). Timeliness in meeting the Project schedule and the overall relationship with the Contractor are factors that will be considered in the Contractor's performance rating. An unfavorable performance rating may be a factor when future assignments are being considered.

6.2 The City makes no representation or warranty of any nature whatsoever as to the accuracy of information or documentation provided by the City to the Contractor which were generated or provided by third parties.

7 Period of Service

7.1 The Contractor shall commence work on the Project after supplying the City with the Contractor's performance and payment bonds and all required insurance documents before starting its Work on this Project. The City shall determine when the Contractor has completed the Work required pursuant to this Agreement, and shall determine the date of Final Acceptance. Contractor recognizes time is of the essence regarding its performance on this Project. Contractor shall continue to perform its obligations while any dispute concerning the Agreement is being resolved, unless otherwise directed by the City.

7.2 Each phase of the project shall be completed in accordance with the activities outlined in the City's Bid 23-22.

8 Payment for Services and Reimbursements

8.1 Within the first five (5) business days of each month, the Contractor shall invoice the City for Work completed during the previous month. The Contractor shall provide a detailed invoice that relates invoiced items to the Contractor's response to Bid 23-22 in both quantity and unit cost. Any discrepancies in the monthly invoice shall be promptly brought to the attention of the Contractor by the City Project Manager and efforts shall be made to promptly resolve said discrepancies between the City and Contractor. In the event the City and Contractor cannot resolve invoice discrepancies, items in dispute will be removed from the invoice and the City shall approve the remainder of the invoice. Payment will be made as soon as possible following the City Council meeting in which the item appeared on the bills list, and in accordance with all applicable laws and rules of the City of Evanston and the State of Illinois.

8.2 In the event of termination by the City of this Agreement pursuant to paragraph 9.1 after completion of any phase of the basic services, fees due the Contractor for services rendered through such phase shall constitute final payment for such services, and no further fees shall be due to the Contractor. In the event of such termination by the City during any phase of the basic services, the Contractor shall be paid for services rendered on the basis of the proportion of work completed on the phase to date of termination.

8.3 The City shall have the right to withhold payment to the Contractor due to the quality of a portion or all of the work performed hereunder which is not in accordance with the requirements of this Agreement, or which is unsatisfactory, or is due to the Contractor's failure or refusal to perform any of its obligations hereunder. Compensation in excess of the total contract amount specified in this Agreement will not be allowed unless justified in the City's sole judgment and authorized in advance as provided for in Section 3 of this Agreement. Compensation for improper performance by the Contractor is disallowed.

8.4 Upon completion of the Work performed by the Contractor, prior to the submission of a request for final payment, the City and Contractor shall perform a final acceptance test and review of the Work performed and/or equipment installed pursuant to the Agreement. A punch list of items outstanding will be jointly developed by the City and Contractor. In addition, the Contractor shall submit drawings of record for the Project for the City to approve. The Contractor shall promptly resolve all punch list items to the satisfaction of the City, and shall transmit to the City in writing confirmation that all punch list items have been resolved. The City will review, and the Contractor shall modify, as necessary, any drawings of record to the satisfaction of the City. Punch list items and drawings of record must be approved by the City prior to the Contractor submitting its final invoice for payment.

8.5 The Contractor shall submit an Affidavit and a final waiver of its lien, and all final

waivers of liens of any sub-contractors, suppliers, and sub-sub-contractors, if applicable, with its final invoice, stating that all obligations incurred in performance of the professional services have been paid in full. The Affidavit will also include a statement stating that the professional services were performed in compliance with the terms of the Agreement. The Affidavit and all final lien waivers shall be on a form acceptable to the City.

8.6 All Project invoices shall be sent to:

City of Evanston
Public Works Agency
2100 Ridge Avenue
Evanston, Illinois 60201

9 Notice and Cure/Termination

9.1 In furtherance of Contractor's Work on this Project, the City and the Contractor agree that the following Notice and Cure provision in this Section 9.1 shall apply during the duration of Contractor's work on this Project, in addition to the reserved rights of the City enumerated in this Agreement as follows:

- 5.1 Liquidated Damages;
- 8.3 City's right to withhold payment;
- 16.2 Contractor's duty to revise and correct errors; and
- 16.3 Contractor's duty to respond to City's notice of errors and omissions.

The City may notify Contractor of its intent to terminate this Agreement within (7) seven calendar days of issuance by the City of written notice to Contractor's Project Manager regarding defects in the Project or in Contractor's Work. The City shall specify any such nonconforming Work or defects in the Project in its notice to Contractor under this Section 9.1. Contractor will have the opportunity to cure the non-conforming Work within (7) seven calendar days after receipt of the written notice issued by the City. All such curative work done shall be performed and completed to the City's satisfaction. Nothing in this Section 9.1 shall otherwise affect the City's right to exercise its rights in Section 9.2.

9.2 The City shall have the right to terminate this Agreement upon fifteen (15) days written notice for any reason. Mailing of such notice shall be equivalent to personal notice and shall be deemed to have been given at the time of receipt.

Payments made by the City pursuant to this Agreement are subject to sufficient appropriations made by the City of Evanston City Council. In the event of termination resulting from non-appropriation or insufficient appropriation by the City Council, the City's obligations hereunder shall cease and there shall be no penalty or further payment required.

9.3 Within thirty (30) days of termination of this Agreement, the Contractor shall turn over to the City any documents, drafts, and materials, including but not limited to, outstanding work

EXHIBIT N

product, data, studies, test results, source documents, AutoCAD Version 2007, ArcView, PDF, Word, Excel spreadsheets, technical specifications and calculations, and any other such items specifically identified by the City related to the Work herein. Upon receipt of said items, the Contractor shall be paid for labor and expenses incurred to the date of termination as provided in Section 8.2. This Agreement is subject to termination by either party if either party is restrained by a state or federal court of competent jurisdiction from performing the provisions of this Agreement. Upon such termination, the liabilities of the parties to this Agreement shall cease, but they shall not be relieved of the duty to perform their obligations through the date of termination. No lien shall be filed by the Contractor in the event of a termination of this Agreement by the City.

9.4 If, because of death or any other occurrence, including, but not limited to, Contractor becoming insolvent, it becomes impossible for any principal or principals of the Contractor to render the services set forth in this Agreement, neither the Contractor, nor its surviving principals shall be relieved of their obligations to complete the professional services. However, in the event of such an occurrence, the City at its own option may terminate this Agreement if it is not furnished evidence that competent professional services can still be furnished as scheduled.

9.5 In the event of an emergency or threat to the life, safety or welfare of the citizens of the City, the City shall have the right to terminate this Agreement without prior written notice.

10 Insurance

10.1 The Contractor shall, at its own expense, secure and maintain in effect throughout the duration of this contract, insurance against claims for injuries to persons or damages to property which may arise from or in connection with the performance of the Work hereunder by the Contractor, its agents, representatives, employees or sub-contractors. Contractor acknowledges and agrees that if it fails to comply with all requirements of this Section 10, the City may void the Agreement.

The Contractor must give to the City Certificates of Insurance identifying the City to be an Additional Insured for all Work done pursuant to this Agreement before City staff recommends award of the contract to City Council. Any limitations or modifications on the Certificate(s) of Insurance issued to the City in compliance with this Section that conflict with the provisions of this Section 10 shall have no force and effect.

After award of the Contract to Contractor (contracts over \$500,000 in value or if the project is deemed high risk) the Contractor **shall** give the City a certified copy (ies) of the insurance policy (ies) evidencing the amounts set forth in Section 10.2, and copies of the Additional Insured endorsement to such policy (ies) which name the City as an Additional Insured for all Work done pursuant to this Agreement before Contractor does any Work pursuant to this Agreement. Contractor's certificate of insurance shall contain a provision that the coverage afforded under the policy(s) will not be canceled or reduced without thirty (30) days prior written notice (hand delivered or registered mail) to the City. Contractor shall promptly forward new certificate(s) of insurance evidencing the coverage(s) required herein upon annual renewal of the subject policies.

The policies and the Additional Insured endorsement must be delivered to the City within two (2) weeks of the request. All insurance policies shall be written with insurance companies licensed or authorized to do business in the State of Illinois and having a rating of not less than A-VII according to the A.M. Best Company. Should any of the insurance policies be canceled before the expiration date, the issuing company will mail thirty (30) days written notice to the City. The Contractor shall require and verify that all sub-contractors maintain insurance meeting all of the requirements stated herein.

Any deductibles or self-insured retentions must be declared to and approved by the City. At the option of the City, either the insurer shall reduce or eliminate such deductibles or self-insured retentions as respects the City, its officers, officials, employees and volunteers; or the Contractor shall provide a financial guarantee satisfactory to the City guaranteeing payment of losses and related investigations, claim administration and defense expenses.

10.2 Contractor shall carry and maintain at its own cost with such companies as are reasonably acceptable to City all necessary liability insurance (which shall include as a minimum the requirements set forth below) during the term of this Agreement, for damages caused or contributed to by Contractor, and insuring Contractor against claims which may arise out of or result from Contractor's performance or failure to perform the Services hereunder:

- a) Worker's compensation in statutory limits and employer's liability insurance in the amount of at least five hundred thousand dollars (\$500,000);
- b) Comprehensive general liability coverage which designates the City as an additional insured for not less than three million dollars (\$3,000,000) combined single limit for bodily injury, death and property damage, per occurrence;
- c) Comprehensive automobile liability insurance covering owned, non-owned, and leased vehicles for not less than one million dollars (\$1,000,000) combined single limit for bodily injury, death, or property damage, per occurrence; and

Contractor understands that the acceptance of Certificates of Insurance, policies, and any other documents by the City in no way releases the Contractor and its sub-contractors from the requirements set forth herein.

Contractor expressly agrees to waive its rights, benefits and entitlements under the "Other Insurance" clause of its commercial general liability insurance policy as respects the City. Contractor expressly agrees that its insurance coverage is required to be primary by this Agreement, that its insurance coverage shall be on a primary and non-contributory basis, and that it and its insurance carrier are estopped from denying such coverage is primary. In the event Contractor fails to purchase or procure insurance as required above, the parties expressly agree that Contractor shall be in default under this Agreement, and that the City may recover all losses, attorney's fees and costs expended in pursuing a remedy, or reimbursement, at law or in equity, against Contractor.

11 Indemnification

- 11.1 The Contractor shall defend, indemnify and hold harmless the City and its officers,

elected and appointed officials, agents, and employees from any and all liability, losses, or damages as a result of claims, demands, suits, actions, or proceedings of any kind or nature, including but not limited to costs, and fees, including attorney's fees, judgments or settlements, resulting from or arising out of any negligent or willful act or omission on the part of the Contractor or Contractor's sub-contractors, employees, agents or sub-contractors during the performance of this Agreement. Such indemnification shall not be limited by reason of the enumeration of any insurance coverage herein provided. This provision shall survive completion, expiration, or termination of this Agreement.

11.2 Nothing contained herein shall be construed as prohibiting the City, or its officers, agents, or employees, from defending through the selection and use of their own agents, attorneys, and experts, any claims, actions or suits brought against them. The Contractor shall be liable for the costs, fees, and expenses incurred in the defense of any such claims, actions, or suits. Nothing herein shall be construed as a limitation or waiver of defenses available to the City and employees and agents, including but not limited to the Illinois Local Governmental and Governmental Employees Tort Immunity Act, 745 ILCS 10/1-101 *et seq.*

At the City Corporation Counsel's option, Contractor must defend all suits brought upon all such Losses and must pay all costs and expenses incidental to them, but the City has the right, at its option, to participate, at its own cost, in the defense of any suit, without relieving Contractor of any of its obligations under this Agreement. Any settlement of any claim or suit related to this Project by Contractor must be made only with the prior written consent of the City Corporation Counsel, if the settlement requires any action on the part of the City.

To the extent permissible by law, Contractor waives any limits to the amount of its obligations to indemnify, defend, or contribute to any sums due under any Losses, including any claim by any employee of Contractor that may be subject to the Illinois Workers Compensation Act, 820 ILCS 305/1 *et seq.* or any other related law or judicial decision, including but not limited to, *Kotecki v. Cyclops Welding Corporation*, 146 Ill. 2d 155 (1991). The City, however, does not waive any limitations it may have on its liability under the Illinois Workers Compensation Act, the Illinois Pension Code or any other statute.

11.3 The Contractor shall be responsible for any losses and costs to repair or remedy work performed under this Agreement resulting from or arising out of any act or omission, neglect, or misconduct in the performance of its Work or its sub-contractors' work. Acceptance of the work by the City will not relieve the Contractor of the responsibility for subsequent correction of any such error, omissions and/or negligent acts or of its liability for loss or damage resulting therefrom.

11.4 All provisions of this Section 11 shall survive completion, expiration, or termination of this Agreement.

12 Drawings and Documents

12.1 Any drawings, survey data, reports, studies, specifications, estimates, maps, plans, computations, and other documents required to be prepared by the Contractor for the Project shall be

considered Works for Hire and the sole property of the City.

12.2 The Contractor and its sub-contractor shall maintain for a minimum of three (3) years after the completion of this Agreement, or for three (3) years after the termination of this Agreement, whichever comes later, adequate books, records and supporting documents to verify the amounts, recipients and uses of all disbursements of funds passing in conjunction with the Agreement. The Agreement and all books, records and supporting documents related to the Agreement shall be available for review and audit by the City and the federal funding entity, if applicable, and the Contractor agrees to cooperate fully with any audit conducted by the City and to provide full access to all materials. Failure to maintain the books, records and supporting documents required by this Subsection shall establish a presumption in favor of the City for recovery of any funds paid by the City under the Agreement for which adequate books, records, and supporting documentation are not available to support their purported disbursement.

13 Successors and Assigns

13.1 The City and the Contractor each bind themselves and their partners, successors, executors, administrators, and assigns to the other party of the Agreement and to the partners, successors, executors, administrators, and assigns of such other party in respect to all covenants of this Agreement. Neither the City nor the Contractor shall assign, sublet, or transfer its interest in this Agreement without the written consent of the other. Nothing herein shall be construed as creating any personal liability on the part of any officer or agent of any public body, which may be a party hereto, nor shall it be construed as giving any right or benefits hereunder to anyone other than the City and the Contractor.

14 Force Majeure

14.1 Whenever a period of time is provided for in this Agreement for the Contractor or the City to do or perform any act or obligation, neither party shall be liable for any delays or inability to perform if such delay is due to a cause beyond its control and without its fault or negligence including, without limitation:

- a) Acts of nature;
- b) Acts or failure to act on the part of any governmental authority other than the City or Contractor, including, but not limited to, enactment of laws, rules, regulations, codes or ordinances subsequent to the date of this Agreement;
- c) Acts of war;
- d) Acts of civil or military authority;
- e) Embargoes;
- f) Work stoppages, strikes, lockouts, or labor disputes;
- g) Public disorders, civil violence, or disobedience;
- h) Riots, blockades, sabotage, insurrection, or rebellion;
- i) Epidemics or pandemics;
- j) Terrorist acts;
- k) Fires or explosions;
- l) Nuclear accidents;

- m) Earthquakes, floods, hurricanes, tornadoes, or other similar calamities;
- n) Major environmental disturbances; or
- o) Vandalism.

If a delay is caused by any of the *force majeure* circumstances set forth above, the time period shall be extended for only the actual amount of time said party is so delayed. Further, either party claiming a delay due to an event of *force majeure* shall give the other party written notice of such event within three (3) business days of its occurrence or it shall be deemed to be waived.

15 Amendments and Modifications

15.1 Except as otherwise provided herein, the nature and scope of Work specified in this Agreement may only be modified by a written Change Order, or a written amendment to this Agreement, approved by both parties. This Agreement may be modified or amended from time to time provided, however, that no such amendment or modifications shall be effective unless reduced to writing and duly authorized and signed by the authorized representatives of the parties.

16 Standard of Care & Warranty

16.1 The Contractor shall perform all of the provisions of this Agreement to the satisfaction of the City. The City shall base its determination of the Contractor's fulfillment of the scope of the work in accordance with generally accepted professional standards applicable to the Work for this Project. The Contractor shall perform all of the provisions of this Agreement with that degree of care and skill ordinarily exercised by members of the same profession currently practicing under similar conditions.

16.2 The Contractor shall be responsible for the accuracy of its professional services under this Agreement and shall promptly make revisions or corrections resulting from its errors, omissions, or negligent acts without additional compensation. The City's acceptance of any of the Contractor's professional services shall not relieve the Contractor of its responsibility to subsequently correct any such errors or omissions. If a Contractor has provided the City with specifications for this Project which are determined to be incorrect or which require revision during the solicitation process (including but not limited to Requests for Proposals, Requests for Qualifications, or bids), the Contractor shall make such corrections or revisions to the specifications at no cost to the City. Further, upon receipt of an invoice from the City, the Contractor shall promptly reimburse the City for the reasonable costs associated with the preparation and dissemination of said corrections or revisions to appropriate parties, including but not limited to preparation of the corrected or revised documents, and printing and distribution costs.

16.3 During the pendency of its Work on this Project, the Contractor shall respond to the City's notice of any errors or omissions within twenty-four (24) hours. The Contractor shall be required to promptly visit the Project site(s) if directed to by the City.

16.4 The Contractor shall comply with all federal, state, and local statutes, regulations,

rules, ordinances, judicial decisions, and administrative rulings applicable to its performance under this Agreement.

16.5 Contractor guarantees and warrants to the City that:

- a) All materials and equipment furnished under this Agreement shall be of good quality and new, unless otherwise required or permitted by the Contract Documents;
- b) The Work of this Agreement shall be free from defects which are not inherent in the quality required; and
- c) The Work shall comply with the requirements set forth in the Contract Documents.

This warranty and guarantee shall be for a period of one (1) year from the date of completion and Final Acceptance of the Work by the City, or as otherwise provided in the Contract Documents.

If, within the one year warranty period, after the Contractor has received a final payment under this Agreement, any of the Work is found to be not be in accordance with the requirements of this Agreement, or where defects in materials or workmanship may appear, or be in need of repair, the Contractor shall correct non-conforming and/or defective work or materials promptly after receipt of written notice from the City. Contractor shall immediately at its own expense repair, replace, restore, or rebuild any such Work. This remedy is in addition to any other legal or equitable remedies the City may have under this Agreement or the law.

This guarantee and warranty shall not relieve Contractor of liability for latent defects, and shall be in addition to the City's rights under the law or other guarantees or warranties, express or implied.

16.6 The provisions of this Section 16 shall survive the completion, expiration or termination of this Agreement.

17 Savings Clause

17.1 If any provision of this Agreement, or the application of such provision, shall be rendered or declared invalid by a court of competent jurisdiction, or by reason of its requiring any steps, actions, or results, the remaining parts or portions of this Agreement shall remain in full force and effect.

18 Non-Waiver of Rights

18.1 No failure or delay by the City to exercise any power given to it hereunder or to insist upon strict compliance by Contractor with its obligations hereunder, nor any payment made by the City under this Agreement, shall constitute a waiver of the City's right to demand strict compliance with the terms hereof, unless such waiver is in writing and signed by the City.

19 Entire Agreement

19.1 This Agreement sets forth all the covenants, conditions and promises between the parties with regard to the subject matter set forth herein. There are no covenants, promises, agreements, conditions or understandings between the parties, either oral or written, other than those contained in this Agreement. This Agreement has been negotiated and entered into by each party with the opportunity to consult with its counsel regarding the terms therein. No portion of the Agreement shall be construed against a party due to the fact that one party drafted that particular portion as the rule of *contra proferentem* shall not apply.

20 Governing Law

20.1 This Agreement shall be construed in accordance with and subject to the laws and rules of the City of Evanston and the State of Illinois both as to interpretation and performance. Venue for any action arising out of or due to this Agreement shall be in Cook County, Illinois. The City shall not enter into binding arbitration to resolve any dispute related to this Agreement. The City does not waive tort immunity by entering into this Agreement.

21 Ownership of Contract Documents

21.1 Contractor is specifically prohibited from using in any form or medium, the name or logo of the City for public advertisement, unless expressly granted written permission by the City. Submission or distribution of documents to meet official regulatory requirements or for similar purposes in connection with this Project is not to be construed as publication in derogation of the City’s reserved rights.

22 Notice

22.1 Any notice required to be given by this Agreement shall be deemed sufficient if made in writing and sent by certified mail, return receipt requested, or by personal service, to the persons and addresses indicated below or to such other addresses as either party hereto shall notify the other party of in writing pursuant to the provisions of this Subsection:

City of Evanston Project Manager, Bid 23-22
2100 Ridge Avenue
Evanston, Illinois 60201

if to the Contractor:



22.2 Mailing of such notice as and when provided above shall be equivalent to personal notice and shall be deemed to have been given at the time of mailing.

23 Severability

23.1 Except as otherwise provided herein, the invalidity or unenforceability of any particular provision, or part thereof, of this Agreement shall not affect the other provisions, and this Agreement shall continue in all respects as if such invalid or unenforceable provision had not been contained herein.

24 Execution of Agreement

24.1 This Agreement shall be signed last by the City Manager.

25 Counterparts

25.1 For convenience, this Agreement may be executed in any number of counterparts, each of which shall be deemed to be an original.

26 Authorizations

26.1 The Contractor's authorized representatives who have executed this Agreement warrant that they have been lawfully authorized by the Contractor's board of directors or its bylaws to execute this Agreement on its behalf. The City Manager affirms that he/she has been lawfully authorized to execute this Agreement. The Contractor and the City shall deliver upon request to each other copies of all articles of incorporation, bylaws, resolutions, ordinances, or other documents which evidence their legal authority to execute this Agreement on behalf of their respective parties.

27 Time of Essence

27.1 Time is of the essence with respect to each provision hereof in which time is a factor.

IN WITNESS WHEREOF, the parties hereto have caused this Agreement to be signed by their duly authorized representatives. The effective date of this Agreement will be the date this Agreement is signed by the City Manager.

CONTRACTOR

By: _____

Name: _____

Its: _____

Date: _____

CITY OF EVANSTON

By: _____

Luke Stowe

Its: City Manager

Date: _____

Approved as to form:

By: _____

Nicholas E. Cummings

Its: Corporation Counsel

Revision: April 2021

EXHIBIT O

BID BOND SUBMITTAL LABEL

CUT AND ATTACH LABEL ON OUTSIDE OF SEALED BID BOND SUBMITTAL

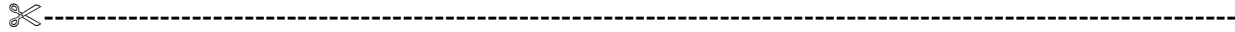

BID SUBMITTAL NUMBER: _____

BID SUBMITTAL NAME: _____

BID SUBMITTAL DUE DATE/TIME: _____

COMPANY NAME: _____

COMPANY ADDRESS: _____

COMPANY TELEPHONE #: _____



If required by the bid documents, a scanned copy of the bid bond must be included with the bid electronic submission. The City is currently not able to accept a certified check, bank cashier's check or electronic bid bond at this time.

The original bid bond (in the amount of 5% of the original bid amount) must be mailed within ten (10) days after the bid due date, to the City of Evanston Purchasing Department, 2100 Ridge Avenue - Room 4200 Evanston, Illinois 60201 Attention Purchasing Manager using the USPS (certified or priority), UPS or FedEx mail options in order to have a tracking number; which sum shall be forfeited in case the successful bidder fails to enter into a binding contract and provide a properly executed contract and surety bond within 15 days after the date the contract is awarded by the City.

SECTION 01 00 00

PROJECT REQUIREMENTS

PART 1 – GENERAL

1.1 GENERAL NOTE

- A. The following requirements are a component part of all contract divisions and form a part of each specification section in so far as they may be in any way applicable thereto.

1.2 RELATED WORK

- A. Drawings and general provisions of the Contract, including General and Supplementary Conditions and all other Divisions of the Project Manual, apply to this section.

1.3 PROJECT SUMMARY

- A. Work on this project includes, installation of Owner provided acoustic panels at the Robert Crown Community Center's gymnasium.

1.4 SPECIAL PROCEDURES AND REQUIREMENTS

A. Fire Protection

1. Regulations: The Contractor shall comply with all federal, state and local fire regulations.
2. Fires: The Contractor shall prohibit the lighting of fires about the premises and use due diligence to see that such prohibition is enforced. Debris and waste materials shall not be burned at the construction site but shall be promptly removed to prevent the accumulation of combustibles on the site.
3. Smoking: Smoking shall be restricted to designated exterior locations. The Contractor shall furnish and post "NO SMOKING" signs at appropriate locations throughout the site where operations are conducted.
4. Flammables: Gasoline and other fuels shall be kept and handled from National Board of Fire underwriter's approved safety cans and shall be stored away from hazardous work areas.

B. Limit of Contractor's Operations

1. Work Areas: Work areas shall be confined to the limits of the construction site. The allotment of work areas within the site to Subcontractors shall be made by the Contractor. The general scheme of operations, work area assignments and use of the job site shall be subject to the Owner's approval.
2. Site Access: Uncontrolled or unrestricted site access will not be permitted for materials, debris or equipment. All access routes and methods shall be controlled by the Contractor so as to minimize the disruption of the Owner's operations and shall be subject to approval by the Owner. Walks, roads and other existing site features used in moving materials shall be properly protected to prevent damage thereto.

C. Hoists, Scaffolds and Ladders

1. Hoists: The Contractor shall furnish, erect, operate and maintain suitable hoisting equipment as may be necessary for constructing the work. Material hoists shall

CROWN ACOUSTIC PANELS

be constructed and maintained in accordance with all applicable federal, state and local laws, regulations and ordinances. Location of hoists shall be subject to approval by the Owner's representative.

2. Scaffolds and Ladders: The Contractor shall furnish, erect, maintain and move all scaffold and ladders required for his work. Scaffolds shall be constructed and maintained in accordance with all applicable federal, state and local laws, regulations and ordinances. Scaffolds and ladders shall be promptly removed after their purpose has been served.

D. Documentation of Existing Conditions

1. Before starting any work, the Contractor shall examine the site to be worked on and the grounds in the staging area and areas adjacent to the site that will be worked on for any existing damage. The Contractor should notify the City's representative of any damage found immediately. The City will photograph and note any existing damage that has been brought to his attention by the Contractor. After the Work has been completed the City will inspect the area used by the Contractor. If any damage is found that was not reported previously, this damage would be considered to have been done by the Contractor. The cost to repair said damage shall be solely borne by the Contractor.

1.5 TEMPORARY CONSTRUCTION FACILITIES

- A. The following temporary utilities and facilities on the construction site shall be provided by the party indicated below:

<u>ITEM</u>	<u>PROVIDER</u>
Telephone	General Contractor
Electricity	City
Water	City
Toilets	City
Parking spaces for Contractor vehicles	Within existing Crown parking lot
Parking spaces for workmen	Within existing Crown parking lot
Storage areas & facilities	Limited unsecured space within job site
Temporary heat	N/A
Job-site trailers & offices	N/A

**PART 2 – PRODUCTS
(NOT APPLICABLE)**

**PART 3 – EXECUTION
(NOT APPLICABLE)**

END OF SECTION 01 00 00

SECTION 01 01 00

SUMMARY OF WORK

PART 1 – GENERAL

1.1 WORK COVERED BY CONTRACT DOCUMENTS

- A. The Project Manual and accompanying drawings are intended to cover the work necessary to construct the various headings of work as described in detail herein.
- B. The work to be performed under this contract shall consist of the furnishing of all materials, equipment, supplies, labor and transportation, and performing all work as required to strictly conform to the provisions of the specifications, schedules and drawings, all of which are made a part herein, together with such detail drawings as may be furnished by the Owner from time to time during the prosecution of the work in amplification of said drawings and specifications.

1.2 RELATED WORK

- A. Drawings and general provisions of the Contract, including General and Supplementary Conditions and all other Divisions of the Project Manual, apply to this section.

1.3 CONTRACT ORGANIZATION

- A. This Construction Project is organized under a single contract between the Owner and the Contractor. The Contractor is responsible for all plans and specification sections as presented in this project manual.

1.4 WORK SEQUENCE

- A. All work and sequence of operations shall be as scheduled in conjunction with all subcontractors, and the Owner in such a manner as not to hinder or delay any other contractors in the progress of their work, and to an end that will expedite the work to completion at the earliest possible date.
- B. Both Contractor and Subcontractor shall cooperate to execute their work as scheduled to minimize the delays to each other and to cause the least inconvenience to the Owner and the public.

1.5 CONTRACTORS' USE OF PREMISES

- A. The Contract shall limit his use of the premises for work and for storage to allow for:
 - 1. Work by other contractors
 - 2. Owner occupancy
 - 3. Public use
- B. Coordinate the use of the premises under direction of the Owner. Stage work so as to avoid disruption to Owner's operation.
- C. Assume full responsibility for the protection and safekeeping of products under this Contract, which are stored at the project site or on the Contractor's property.

CROWN ACOUSTIC PANELS

- D. Move any stored products, under Contractor's control, which interfere with operation of the Owner or separate contractor.
- E. Obtain and pay for the use of additional storage or work areas needed for operations.

1.6 OWNER OCCUPANCY

- A. Owner and public will occupy the Robert Crown Community Center during construction. The gymnasium space will be closed to the public during the contractor's installation work during normal business hours however, during the evenings and weekends the gymnasium space will be open for public use. As a result, the Contractor must store materials and equipment in a location acceptable to both the Contractor and City in a consolidated portion of the gym.

1.7 LINES, LEVELS AND LAYOUT OF WORK

- A. The Contractor shall establish and guarantee all lines, levels, etc. called for on the drawings, including the lines, levels, etc. of all Subcontractors.

1.8 WORK HOURS

- A. Work hours are 7:00 am to 7:00 pm, Monday through Friday and 8:00 am to 5:00 pm on Saturday. No work is allowed on Sundays. Access to the site will not be allowed outside of normal work hours.

1.9 CONTRACTOR'S DUTIES

- A. Except as specifically noted, provide and pay for:
 - 1. Labor, materials and equipment.
 - 2. Tools, construction equipment and machinery
- B. Promptly submit written notice to the Architect of any observed variance of the Contract Documents from legal requirements. It is not the Contractor's responsibility to make certain that the Drawings and Specifications comply with codes and regulations.
 - 1. Appropriate modifications to the Contract Documents will adjust the necessary changes.
 - 2. The Contractor shall assume responsibility for work known to be contrary to such requirements, and performed without such notice.
- C. Enforce strict discipline and good order among employees. Do not employ on work:
 - 1. Unfit persons
 - 2. Persons not skilled in assigned task
- D. Existing Conditions
 - 1. The Contractor shall be responsible for obtaining and verifying all dimensions. Any dimension give in the Drawings referring to existing construction were taken from the original construction documents and are provided for information only.

CROWN ACOUSTIC PANELS

2. Where conditions are uncovered that are not anticipated by the Drawings and Specifications, the Contractor shall notify the Engineer and Owner's Representative immediately, before any modification or other work is initiated.

1.10 SITE PROTECTION

- A. Contractor shall protect from damage existing room finishes and fixtures including the flooring, walls, doors, windows, panels, electronic devices, equipment, etc. Contractor shall protect from damage all areas used to move materials and equipment within the building such as floors, stairs, elevators, etc. In the event of any damage, Contractor shall notify the Owner immediately and make all repairs and replacements necessary to restore damaged items to their original condition at no additional cost to the Owner.
- B. During normal business hours and while work is being performed, Contractor shall protect site from public entry using warning signs, caution tape and similar items.
- C. Outside of normal business hours, the gymnasium will be open for public use. Contractor shall secure their materials and equipment in a mutually acceptable location within the gym to both the Contractor and the City that is out of the way of scheduled gym activities.

**PART 2 – PRODUCTS
(NOT APPLICABLE)**

**PART 3 – EXECUTION
(NOT APPLICABLE)**

END OF SECTION 01 01 00

SECTION 01 02 70

APPLICATIONS FOR PAYMENT

PART 1 – GENERAL

1.1 SUMMARY

- A. Contractor shall comply with procedures described in this Section when applying for progress payments and final payment under the Contract.

1.2 RELATED WORK

- A. Drawings and general provisions of the Contract, including General and Supplementary Conditions and all other Divisions of the Project Manual, apply to this Section.

1.3 QUALITY ASSURANCE

- A. Prior to start of construction, secure the Owner's approval of the schedule of values required to be submitted as specified below.
- B. During progress of the Work, modify the schedule of values as approved by the Owner to reflect changes in the Contract Sum due to Change Orders or other modifications of the Contract.
- C. All requests for payment shall be based on the approved Schedule of Values for the project.
- D. All modifications to the contract shall be based on the approved Schedule of Values for the project.

1.4 SCHEDULE OF VALUES

- A. Coordinate preparation of the Schedule of Values with preparation of the Contractor's Construction Schedule.
 - 1. Correlate line items in the Schedule of Values with other required administrative schedules and forms, including:
 - a. Contractor's construction schedule.
 - b. Application for Payment forms.
 - c. List of subcontractors.
 - d. Schedule of alternates.
 - e. List of products.
 - f. List of principal suppliers and fabricators.
 - g. Schedule of submittals.
 - 2. Submit the Schedule of Values to the Owner at the earliest feasible date, but in no case later than seven (7) days before the date scheduled for submittal of the initial Application for Payment.

CROWN ACOUSTIC PANELS

- B. If applicable, the format and content of the Schedule of Values shall match the project's unit pricing. The Contractor is strongly encouraged to utilize spreadsheet software for preparation of all pay applications.
1. Include the following Project identification on the Schedule of Values:
 - a. Project name and location.
 - b. Purchase order number.
 - c. Contractor's name and address.
 - d. Date of submittal.
 2. Arrange the Schedule of Values in tabular form with separate columns to indicate the following for each item listed:
 - a. Itemized description.
 - b. Related Specification Section
 - c. Name of subcontractor.
 - d. Name of manufacturer or fabricator.
 - e. Name of supplier.
 - f. Change Orders (numbers) that have affected value.
 - g. Dollar value.
 - h. Percentage of Contract Sum to the nearest one-hundredth percent, adjusted to total 100 percent.
 3. For each part of the Work where an Application for Payment may include materials or equipment, purchased or fabricated and stored, but not yet installed, provide separate line items on the Schedule of Values for initial cost of the materials, for each subsequent stage of completion, and for total installed value of that part of the Work.
 4. Show line items for indirect costs and margins on actual costs, only to the extent that such items will be listed individually in Applications for Payment. Each item in the Schedule of Values and Applications for Payment shall be complete including its total cost and proportionate share of general overhead and profit margin.
 5. Update and resubmit the Schedule of Values when Change Orders result in a change in the Contract Sum.

1.5 PROCEDURES

A. Informal submittal

1. Make informal submittal of request for payment by filling in, with erasable pencil, pertinent portions of AIA Document G702, "Application and Certification for Payment," plus continuation sheet or sheets of AIA Document G703.
2. Make this preliminary submittal to the Architect and Owner in accordance with the Owner's payment schedule.
3. Revise the informal submittal of the request for payment as directed by the Owner, initialing all copies.

B. Formal submittal

1. Make formal submittal of request for payment by filling in the agreed data, by typewriter or neat lettering in ink, on AIA Document G702, "Application and Certification for Payment," plus continuation sheet(s) of AIA Document G703.
2. Sign and notarize the Application and Certificate for Payment.

CROWN ACOUSTIC PANELS

3. Reference Purchase Order number on Application for Payment
4. Secure and file with submittal progress waivers for all materials incorporated into and labor and equipment employed on the work before payment requests are processed.
 - a. Initial payment will be processed without progress waivers. Subsequent requests will require progress waivers for previous payment.
5. Submit the original of the Application and Certificate for Payment and the continuation sheet or sheets to the Architect and Owner for approval.
6. The Architect and Owner will compare the formal submittal with the approved informal submittal and, when approved, will sign the Application and Certificate for Payment, will make and distribute required copies. The Owner will disburse directly to the Contractor the amount certified less 10% retainage.
7. Approved formal submittals must be received by the Owner in accordance with the Owner's payment schedule.
8. Certified payroll records must be submitted along with the formal submittal as described in the General Conditions.

PART 2 – PRODUCTS

(NOT APPLICABLE)

PART 3 – EXECUTION

(NOT APPLICABLE)

END OF SECTION 01 02 70

SECTION 01 21 00

ALLOWANCES

PART 1 – GENERAL

1.1 RELATED DOCUMENTS

- A. Drawings and general provisions of the Contract, including General and Supplementary Conditions and other Division 1 Specification Sections, apply to this Section.
- B. Other provisions concerning Allowances also may be stated in other Sections of these Specifications.

1.2 SUMMARY

- A. The allowance is general and is to be used to provide adequate budget and bonding to cover items not able to be precisely determined by the Owner prior to bidding including any unforeseen conditions that are discovered. Allow within the proposed Total Base Bid Amount the amounts described in this Section.
- B. Allowance work shall be pre-approved prior to the start of and during the Construction with Proposals documenting the work to be performed, with clearly stated not-to-exceed costs and step by step method of procedures for the proposed work stated. Proposals must be submitted and accepted by the Owner prior to starting any allowance work. After discovering an unforeseen condition, the contractor shall submit a Proposal that includes a report summarizing the found condition. The Consultant and Owner will view the unforeseen condition to determine if the work will be authorized. Allowance work shall only be authorized by written Allowance Authorization. Under no circumstances shall the Contractor move forward with the work in question nor shall the contractor expend allowance without an approved Allowance Authorization.

1.3 ALLOWANCE RESPONSIBILITIES

- A. Contractor's Responsibilities:
 - 1. Assist in selection of products, suppliers and installers.
 - 2. Obtain proposals from suppliers and installers and offer recommendations and review of proposals submitted. Transmit to Owner on Proposal forms, attaching all supporting documentation. Include any bond cost adjustments with the proposal. Include scheduling information and assessment of impact of other work.
 - 3. On notification of selection by Owner, execute purchase agreement with designated supplier and installer.
 - 4. Arrange for and process shop drawings, product data and samples. Arrange for delivery.
 - 5. Promptly inspect products upon delivery for completeness, damage and defects. Submit claims for transportation damage.
 - 6. Document thoroughly all costs related to the work.
 - 7. Provide the Owner with fully documented Proposals detailing all allowance work to be performed.

1.4 ALLOWANCE DOCUMENTATION

CROWN ACOUSTIC PANELS

- A. All work covered by Allowances must be thoroughly documented as follows:
 - 1. Upon encountering any field conditions which is not as shown in Construction Documents, the Contractor shall immediately notify the Owner and develop a written Proposal detailing any additional work required. Proposals shall include a report summarizing the found condition. Contractor work initiated without submitting a completed Proposal and obtaining the Owner's written approval by Allowance Authorization is performed entirely at Contractor's own risk and cost, regardless of any prior verbal approval.
 - 2. The Owner shall review the Contractor's Proposal and, if appropriate, provide written approval via Allowance Authorization for use of the Allowance.

1.5 SCHEDULE OF ALLOWANCES

Allowance Number 1, Additional Work General: \$5,000.00

1.6 ALLOWANCE EXCLUSIONS

- A. General
 - 1. Additional costs related to improper scheduling, sequencing or coordination will not be covered within the Allowance, as determined solely by the Owner.
- B. Existing Building Component Exclusions
 - 1. All work required to protect existing building surfaces and components is included in the Base Bid and will not be covered within the Allowance.

PART 2 – PRODUCTS

(Not Used)

PART 3 – EXECUTION

(Not Used)

END OF SECTION 01 21 00

SECTION 01 56 00

TEMPORARY ENVIRONMENTAL CONTROLS

PART 1 - GENERAL

1.1 WORK INCLUDES

A. Contractors shall:

1. Provide controls over environmental conditions at the construction site and related areas under the Contractor's control.
2. Remove physical evidence of temporary controls at completion of work or as directed.

1.2 RELATED WORK

- A. Drawings and general provisions of Contract, including General and Supplementary Conditions and all other Divisions of the Project Manual, apply to this Section.

1.3 DUST CONTROL

- A. Provide dust control materials to minimize dust from construction operations. Prevent air-borne dust from dispersing into the atmosphere.
- B. Dust- and HVAC-Control Plan: Submit coordination drawing and narrative that indicates the dust- and HVAC-control measures proposed for use, proposed locations, and proposed time frame for their operation. Include the following:
1. Locations of dust-control partitions at each phase of work.
 2. HVAC system isolation schematic drawing.
 3. Location of proposed air-filtration system discharge.
 4. Waste-handling procedures.
 5. Other dust-control measures.

1.4 DEBRIS CONTROL

- A. Maintain all areas under Contractor's control free of extraneous debris.
- B. Initiate and maintain a specific program to prevent accumulation of debris at construction site.
1. Provide containers specified in SECTION 01 71 00 - CLEANING for deposit of debris.
- C. Schedule collection and disposal of debris is specified in SECTION 01 71 00 - CLEANING.
1. Provide additional collections and disposals of debris whenever regular schedule is inadequate to prevent accumulation.

PART 2 - PRODUCTS

CROWN ACOUSTIC PANELS

(NOT APPLICABLE)

PART 3 - EXECUTION

(NOT APPLICABLE)

END OF SECTION 01 56 00

SECTION 01 60 00

MATERIALS AND EQUIPMENT

PART 1 - GENERAL

1.1 SUMMARY

- A. This Section specifies administrative and procedural requirements governing the Contractor's selection of products for use in the Project.
- B. The Contractor's Construction Schedule and the Schedule of Submittals are included under Section 01 30 00 - SUBMITTALS.

1.2 RELATED DOCUMENTS

- A. Drawings and general provisions of Contract, including General and Supplementary Conditions and all other Divisions of the Project Manual, apply to this Section.

1.3 DEFINITIONS

- A. Definitions used in this Article are not intended to change the meaning of other terms used in the Contract Documents, such as "specialties," "systems," "structure," "finishes," "accessories," and similar terms. Such terms are self-explanatory and have well recognized meanings in the construction industry.
 - 1. "Products" are items purchased for incorporation in the Work, whether purchased for the Project or taken from previously purchased stock. The term "product" includes the terms "material," "equipment," "system," and terms of similar intent.
 - 2. "Named Products" are items identified by manufacturer's product name, including make or model designation, indicated in the manufacturer's published product literature, that is current as of the date of the Contract Documents.

1.4 QUALITY ASSURANCE

- A. Source Limitations: To the fullest extent possible, provide products of the same kind, from a single source.
 - 1. When specified products are available only from sources that do not or cannot produce a quantity adequate to complete project requirements in a timely manner, consult with the Owner for a determination of the most important product qualities before proceeding. Qualities may include attributes relating to visual appearance, strength, durability, or compatibility. When a determination has been made, select products from sources that produce products that possess these qualities, to the fullest extent possible.
- B. Compatibility of Options: When the Contractor is given the option of selecting between two or more products for use on the Project, the product selected shall be compatible with products previously selected, even if previously selected products were also options.
 - 1. The Contractor is responsible for providing products and construction methods that are compatible with products and construction methods of subcontractors.
 - 2. If a dispute arises between the general Contractor and subcontractors over concurrently selectable, but incompatible products, the Owner will determine

CROWN ACOUSTIC PANELS

which products shall be retained and which are incompatible and must be replaced.

- C. Nameplates: Except for required labels and operating data, do not attach or imprint manufacturer's or producer's nameplates or trademarks on exposed surfaces of products which will be exposed to view.
 - 1. Labels: Locate required product labels and stamps on a concealed surface or, where required for observation after installation, on an accessible surface that is not conspicuous.
- D. Manufacturer's Instructions
 - 1. When contract documents specify that installation shall comply with manufacturer's printed instructions, obtain and distribute copies of such instructions to all parties involved in the installation, including the Owner.
 - 2. Maintain one set of complete instructions with the Project Record Documents at the job site during installation and until completion.

1.5 PRODUCT DELIVERY, STORAGE, AND HANDLING

- A. Deliver, store and handle products in accordance with the manufacturer's recommendations, using means and methods that will prevent damage, deterioration and loss, including theft.
 - 1. Schedule delivery to minimize long-term storage at the site and to prevent overcrowding of construction spaces.
 - 2. Coordinate delivery with installation time to ensure minimum holding time for items that are flammable, hazardous, easily damaged, or sensitive to deterioration, or theft.
 - 3. Deliver products to the site in the manufacturer's original sealed container or other packaging system, complete with labels and instructions for handling, storing, unpacking, protecting and installing.
 - 4. Inspect products upon delivery to ensure compliance with the Contract Documents, and to ensure that products are undamaged and properly protected.
 - 5. Store products at the site in a manner that will facilitate inspection and measurement of quantity or counting of units.
 - 6. Store heavy materials away from the Project structure in a manner that will not endanger the supporting construction.
 - 7. Store products subject to damage by the elements above ground, under cover in a weathertight enclosure, with ventilation adequate to prevent condensation. Maintain temperature and humidity within range required by manufacturer's instructions.
- B. Arrange for transportation and deliveries of materials and equipment in accord with approved current construction schedules and in ample time to facilitate inspection prior to installation.
- C. Coordinate deliveries to avoid conflict with work and conditions at site:
 - 1. Work of other contractors or Owner, or their use of premises.
 - 2. Limitations of storage space.
 - 3. Availability of equipment and personnel for handling products.

PART 2 - PRODUCTS

2.1 PRODUCT SELECTION

CROWN ACOUSTIC PANELS

- A. General Product Requirements: Provide products that comply with the Contract Documents, that are undamaged and, unless otherwise indicated, unused at the time of installation.
1. Provide products complete with all accessories, trim, finish, safety guards and other devices and details needed for a complete installation and for the intended use and effect.
 2. Standard Products: Where available, provide standard products of types that have been produced and used successfully in similar situations on other projects.
 3. Comply with size, make, type and quality specified.
 4. Manufactured and fabricated products:
 - a. Design, fabricate and assemble in accord with best engineering and shop practices.
 - b. Manufacture like parts of duplicate units to standard interchangeable sizes.
 - c. Two or more items of the same kind shall be identical from the same manufacturer.
 - d. All system parts shall be from the same manufacturer to the greatest extent practical.
 - e. Adhere to equipment capacities, sizes and dimensions shown or specified unless variations are specifically approved by Change Order.
- B. Product Selection Procedures: Product selection is governed by the Contract Documents and governing regulations, not by previous Project experience. Procedures governing product selection include the following:
1. Proprietary Specification Requirements: Where only a single product or manufacturer is named, provide the product indicated. No substitutions will be permitted.
 2. Semi-proprietary Specification Requirements: Where two or more products or manufacturers are named, provide one of the products indicated. No substitutions will be permitted.
 - a. Where products or manufacturers are specified by name, accompanied by the term "or equal," or "or approved equal" comply with the Contract's provisions concerning "substitutions" to obtain approval for use of an unnamed product.
 3. Non-Proprietary Specifications: When the Specifications list products or manufacturers that are available and may be incorporated in the Work, but do not restrict the Contractor to use of these products only, the Contractor may propose any available product that complies with Contract requirements. Comply with Contract Document provisions concerning "substitutions" to obtain approval for use of an unnamed product.
 4. Descriptive Specification Requirements: Where Specifications describe a product or assembly, listing exact characteristics required, with or without use of a brand or trade name, provide a product or assembly that provides the characteristics and otherwise complies with Contract requirements.
 5. Performance Specification Requirements: Where Specifications require compliance with performance requirements, provide products that comply with these requirements, and are recommended by the manufacturer for the application indicated. General overall performance of a product is implied where the product is specified for a specific application.
 - a. Manufacturer's recommendations may be contained in published product literature, or by the manufacturer's certification of performance.

CROWN ACOUSTIC PANELS

6. Compliance with Standards, Codes and Regulations: Where the Specifications only require compliance with an imposed code, standard or regulation, select a product that complies with the standards, codes or regulations specified.
 7. Visual Matching: Where Specifications require matching an established Sample, the Owner's decision will be final on whether a proposed product matches satisfactorily.
 - a. Where no product available within the specified category matches satisfactorily and also complies with other specified requirements, comply with provisions of the Contract Documents concerning "substitutions" for selection of a matching product in another product category, or for noncompliance with specified requirements.
 8. Visual Selection: Where specified product requirements include the phrase "...as selected from manufacturer's standard colors, patterns, textures..." or a similar phrase, select a product and manufacturer that complies with other specified requirements. The Owner will select the color, pattern and texture from the product line selected.
- C. Deliver products in undamaged condition in original containers or packaging, with identifying labels intact and legible.
- D. Clearly mark partial deliveries of component parts or assemblies or equipment to permit easy identification of parts and to facilitate assembly.
- E. Immediately on delivery, inspect shipment to assure:
1. Product complies with contract documents and Owner
 2. Quantities are correct.
 3. Containers and packages are intact and labels are legible.
 4. Products are properly protected and undamaged.

PART 3 - EXECUTION

3.1 INSTALLATION OF PRODUCTS:

- A. Comply with manufacturer's instructions and recommendations for installation of products in the applications indicated. Anchor each product securely in place, accurately located and aligned with other Work.
1. Clean exposed surfaces and protect as necessary to ensure freedom from damage and deterioration at time of Substantial Completion.
- B. Provide equipment and personnel to handle products and equipment, including those furnished by the Owner. Prevent damage to products or packaging.
- C. Provide additional protection during handling to prevent scraping, marring or otherwise damaging products, equipment or surrounding surfaces.
- D. Handle products and equipment in manner to prevent bending or overstressing.
- E. Lift packages, equipment or components only at designated lift points.

END OF SECTION 01 60 00

SECTION 01 71 00

CLEANING

PART 1 - GENERAL

1.1 WORK INCLUDES

- A. Contractor shall maintain premises and public properties free from accumulations of waste, debris, and rubbish, caused by construction operations.
- B. At completion of work, Contractor shall remove waste materials, rubbish, tools, equipment, machinery and surplus materials, clean all sight-exposed surfaces and leave project clean and ready for occupancy.

1.2 RELATED WORK

- A. Drawings and general provisions of Contract, including General and Supplementary Conditions and all other Divisions of the Project Manual, apply to this Section.

1.3 SAFETY REQUIREMENTS

- A. Standards: Maintain project in accord with following safety and insurance standards.
 - 1. Occupational Safety and Health Administration (OSHA).
- B. Hazards Control:
 - 1. Store volatile wastes in covered metal containers and remove from premises daily.
 - 2. Prevent accumulation of wastes which create hazardous conditions.
 - 3. Provide adequate ventilation during use of volatile or noxious substances.
- C. Conduct cleaning and disposal operations to comply with Federal, State and local ordinances and anti-pollution laws.
 - 1. Do not burn or bury debris, rubbish or other waste materials on project site.
 - 2. Do not dispose of volatile wastes such as mineral spirits, oil or paint thinner in storm or sanitary drains.
 - 3. Do not dispose of wastes into streams or waterways.

PART 2 - PRODUCTS

2.1 MATERIALS

- A. Select and use all cleaning materials and equipment with care to avoid scratching, marring, defacing, staining or discoloring surfaces cleaned.
- B. Use only cleaning materials recommended by manufacturer of surface to be cleaned.
- C. Use cleaning materials only on surfaces recommended by cleaning material manufacturer.

PART 3 - EXECUTION

CROWN ACOUSTIC PANELS

3.1 DURING CONSTRUCTION

- A. Execute cleaning to ensure that grounds and public properties are maintained free from accumulations of waste materials and rubbish.
- B. Wet down materials and rubbish to lay dust and to prevent blowing dust.
- C. At reasonable intervals during progress of work, clean site and public properties, and dispose of waste materials, debris and rubbish.
- D. Provide on-site metal containers for collection of waste materials, debris and rubbish.
- E. Remove waste materials, debris and rubbish from site and legally dispose of at public or private dumping areas off Owner's property.
- F. Handle waste materials in a controlled manner with as few handlings as possible; do not drop or throw materials from heights.
- G. Schedule cleaning operations so that dust and other contaminants resulting from cleaning process will not fall on wet, newly painted surfaces.

3.2 FINAL CLEANING

- A. General: Provide final cleaning operations when indicated. Employ experienced workers or professional cleaners for final cleaning. Clean each surface or unit of Work to the condition expected from a commercial building cleaning and maintenance program. Comply with manufacturer's instructions.
- B. In preparation for substantial completion or occupancy, conduct final inspection of sight-exposed interior and exterior surfaces, and of concealed spaces.
- C. Clean the Project site, yard and grounds, in areas disturbed by construction activities, including landscape development areas, of rubbish, waste materials, litter and foreign substances. Sweep paved areas broom clean. Remove petro-chemical spills, stains and other foreign deposits. Rake grounds that are neither planted nor paved, to a smooth even-textured surface.
 - 1. Remove tools, construction equipment, machinery and surplus material from the site.
 - 2. Clean exposed exterior hard-surfaced finishes to a dirt-free condition, free of stains, films and similar foreign substances. Avoid disturbing natural weathering of exterior surfaces. Restore reflective surfaces to their original condition.
 - 3. Remove debris and surface dust from limited access spaces.
 - 4. Remove labels that are not permanent labels.
 - 5. Touch-up and otherwise repair and restore marred exposed finishes and surfaces. Replace finishes and surfaces that can not be satisfactorily repaired or restored, or that show evidence of repair or restoration. Do not paint over "UL" and similar labels, including mechanical and electrical name plates.
 - 6. Clean plumbing fixtures to a sanitary condition, free of stains, including stains resulting from water exposure.
 - 7. Leave the Project clean and ready for occupancy.
- E. Repair, patch and touch up marred surfaces to specified finish, to match adjacent surfaces.
- F. Broom clean paved surfaces; rake clean other surfaces on grounds.

CROWN ACOUSTIC PANELS

- G. Maintain cleaning until project, or designated portion thereof, is occupied by Owner.

END OF SECTION 01 71 00

Robert Crown Community Center
Gymnasium Acoustic Panel Installation
Scope of Work

The City of Evanston is requesting bids from contractors to install acoustic panels at the Robert Crown Community Center's gymnasium. The City will provide the acoustic panels and fastening system materials to the Contractor. The Contractor's scope of work shall be limited to all required work to install the City provided panels.

Sketches detailing the existing gymnasium space, proposed panel layout, panel product, and panel fastening system are attached. These sketches have been field measured by the building's design architect and are intended to avoid existing appurtenances like wall access panels, outlets, Wi-Fi antenna, scoreboards, etc. All panels shall be standard 4'x10' in size. Cutting of panels is not anticipated to be required. Panels shall be installed abutting each other with no gaps between them. Contractor shall be responsible for verifying sketches in the field before installation commences.

The gymnasium is located on the building's second floor. The panels will be on site for the contractor's use but will be stored on the building's first floor. The Contractor is responsible for moving panels from the first floor to the gymnasium on the second floor. Panels are delivered from the factory with fabric already attached. There is no on-site assembly of the panels required. Contractor will be responsible for floor and site protection as well as lifts or scaffolding required to access the work areas. The Robert Crown Center does not have a freight elevator, only a passenger elevator. A small scissor lift may be able to fit in the passenger elevator.

The panels are expected to be delivered to the Robert Crown Community Center in early March 2023.

record drawing set	08.28.20
ASK-050 multipurpose room.202	11.01.19
ASK-025 sound room modification	05.21.19
issued for construction	01.23.19
issued for permit	10.19.18
GMP Addendum #1	6.13.18
GMP	5.24.18
100% DD	4.8.18
DD progress set #2	2.23.18
DD progress set	12.21.17

NOTES

STAINLESS STEEL GUARDS, GUARD EXTENSIONS, PIPE RAILS, BASE RAIL, POST MOUNTED BENCH AND HANDRAIL SYSTEMS
 - SST TYPE 316, IN RINKS 1 AND 2, AND CONCOURSE 218
 - CAS IN FACE ANCHORS, HOT DIP GALVANIZED
 - FINISH EXPOSED WELDS SMOOTH
 - FORM EXPOSED CONNECTIONS WITH HAIRLINE JOINTS, FLUSH AND SMOOTH, WITH CONCEALED WELDS OR FASTENERS WHERE POSSIBLE
 - COUNTERSINK EXPOSED FASTENERS

SPECTATOR BENCHES
 - MOLDED VANDALISM RESISTANT SELF-DRAWING 1/2" WIDE
 - POLISHED POLYPROPYLENE 890C, 1/4" X 1/2" OR EQ.
 - COLOR TO CONSULTANT'S SELECTION FROM FULL RANGE

GRESS STAIRS
 - 12" X 2" FLAT BAR GUARDS, VERTICAL PICKETS AT # O.C. AND TOP AND BOTTOM FLAT BAR RAILS, AND 1/2" CONTINUOUS HANDRAILS, BOTH SIDES OF STAIR GUARDS ARE WELDED TO TOP SIDE OF STRINGERS
 - WIRE HANDRAILS ARE MOUNTED TO WALLS-ANCHOR BARS AT MAXIMUM 4" O.C. ALL FASTENERS COUNTERSINK
 - CONTINUOUS STEEL CHANNEL STRINGERS, NOM. C12@24
 - TREADS: BENCH STEEL, PLATE PANS, 1 1/4" CONCRETE FILL TREADS, C/W CAST IN NON-SLIP COLOR CONTRASTING CARBIDE GRIT STRIP NOSE
 - RISERS: BENT STEEL, CONTINUOUS WITH PANS
 - SST TACTILE WARNING INDICATOR STUDS AT TOP LANDING, BRONSON SAFETY SUPERSTEEL OR EQ.
 - ALL STEEL PAINTED

project team

- owner:
City of Evanston
2100 Ridge Ave
Evanston, IL 60201
847.448.8043
- construction manager:
Bully & Andrews
1755 W. Armitage Ave.
Chicago, IL 60622
773.235.2433
- structural engineer:
Smith+Anderson
223 W. Jackson Blvd., Suite 1111 D
Chicago, IL 60606
312.461.1800
- MEP engineer (EOR, E/P/FP)
CCJM Engineers, Ltd.
303 East Wacker Dr, Suite 303
Chicago, IL 60601
312.626.2977
- MEP engineer (HVAC / Refrigeration)
Smith+Anderson
4211 Yonge Street Suite 500
Toronto Ontario M2P 2A9
416.487.8151
- civil engineer / surveyor
TERRA Engineering, Ltd
225 W. Ohio St., 4th Floor
Chicago, IL 60654
312.457.9123
- landscape architect
Conservation Design Forum
403 West St., Charles Road
Lombard, IL 60148
630.559.2000
- sportsfield consultant:
Jeffrey L. Bruce & Company
1907 Swift Street, Suite 204
North Kansas City, MO 64116
816.842.8999
- acoustics / audio visual:
Anup
35 E Upper Wacker Dr #1800
Chicago, IL 60601
312.849.5610
- lighting design:
Anne Kustner Lighting Design
517 4th Street
Wilmington, IL 60091
847.475.2010
- commissioning agent:
Grumman/Burkus Associates
820 Davis Street, Suite 300
Evanston, IL 60201
847.328.3555

key plan

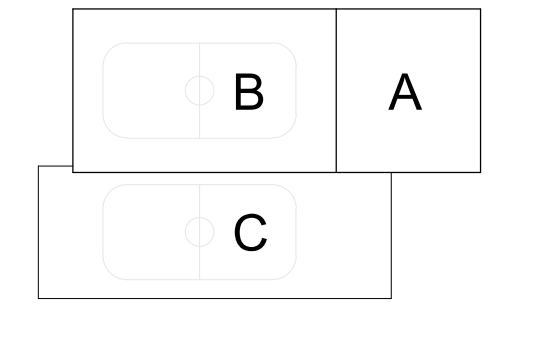

Woodhouse Tinucci Architects
230 W Superior 6th Flr Chicago IL 60654
Tel 312 943 3120 www.woodtinarch.com

MJMA
6-425 Adelaide Street West
Toronto Ontario M5V 3C1
416.593.0788
mjmaarchitects.com

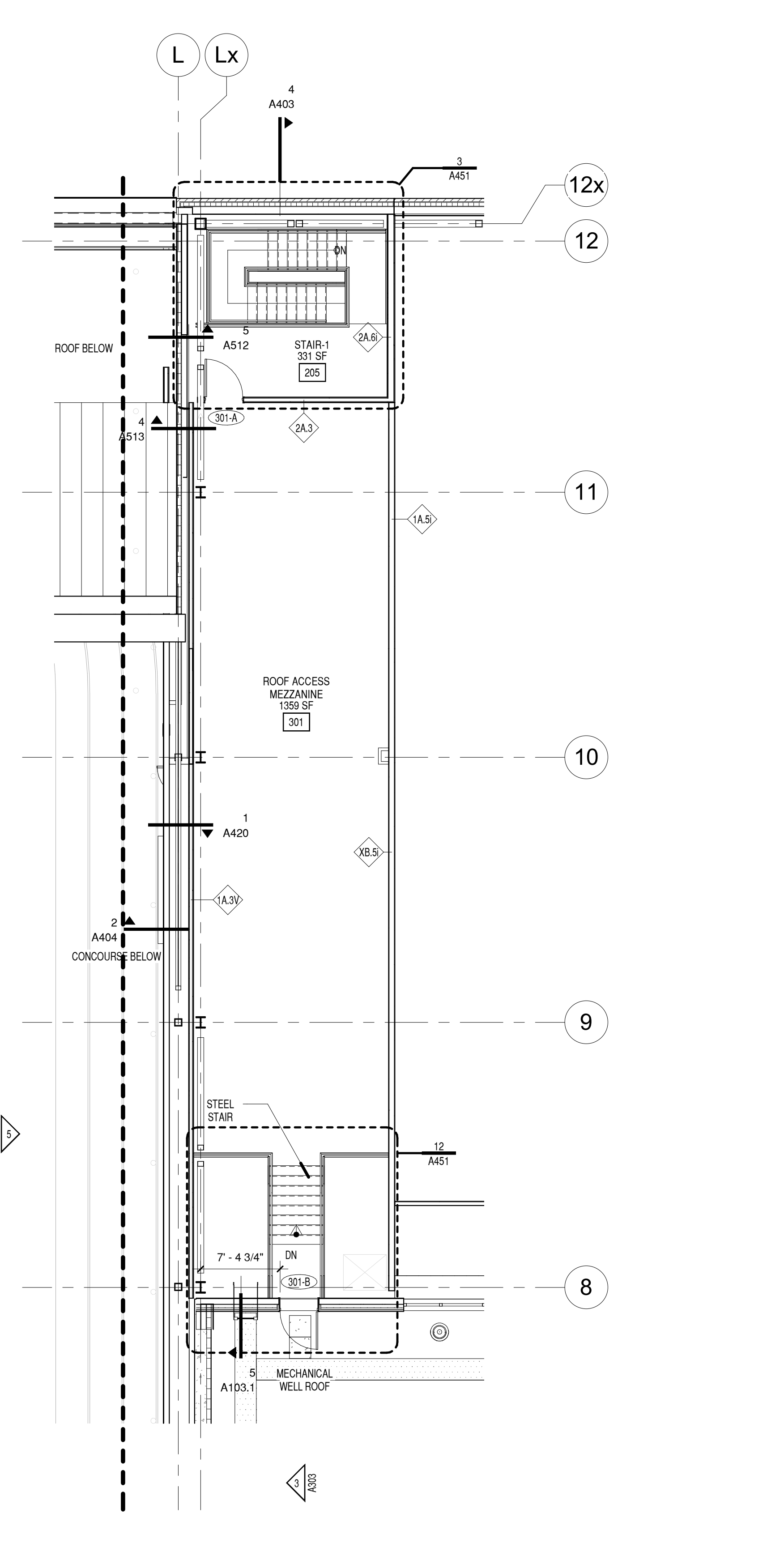
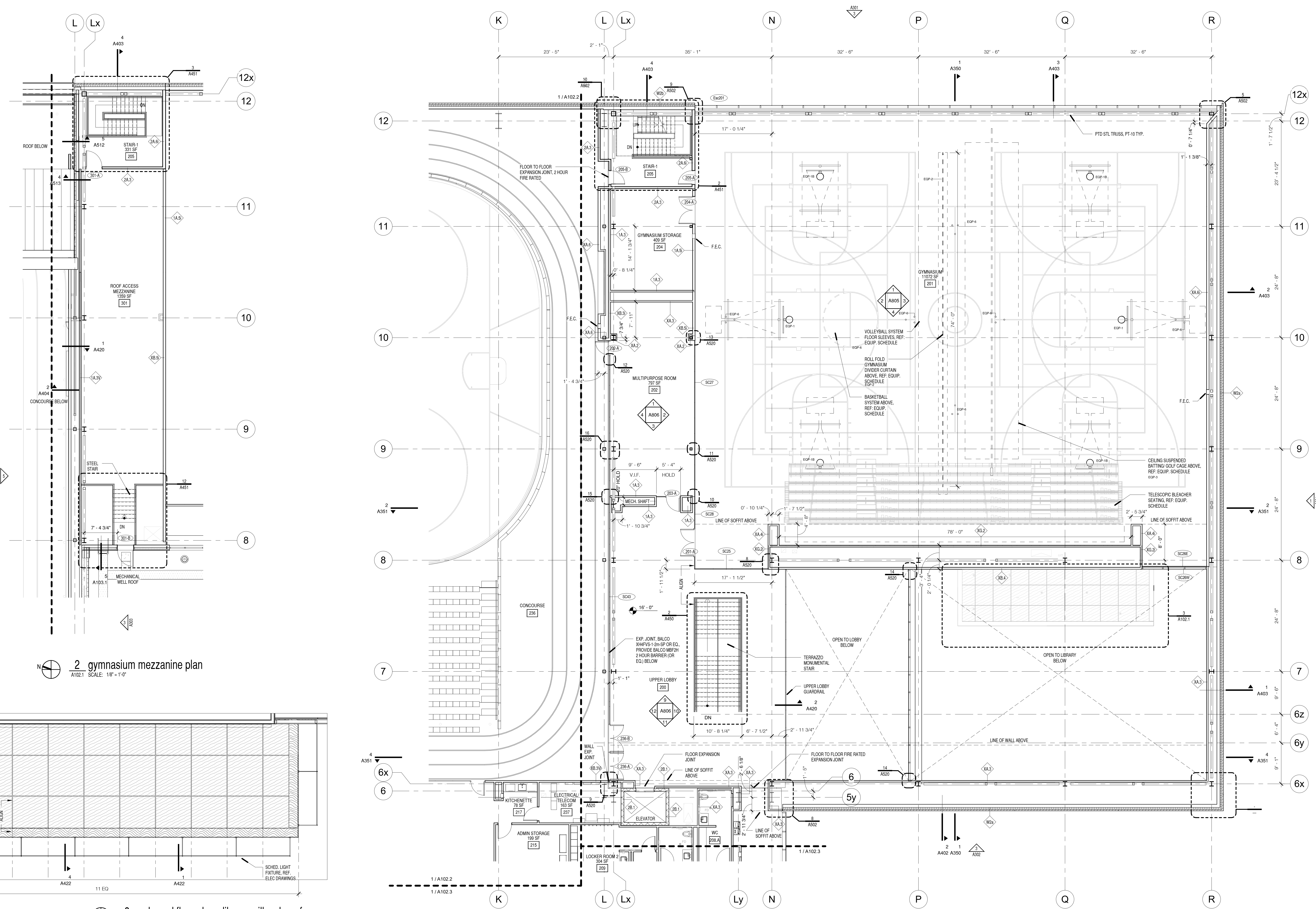

2 gymnasium mezzanine plan
A102.1 SCALE: 1/8" = 1'-0"

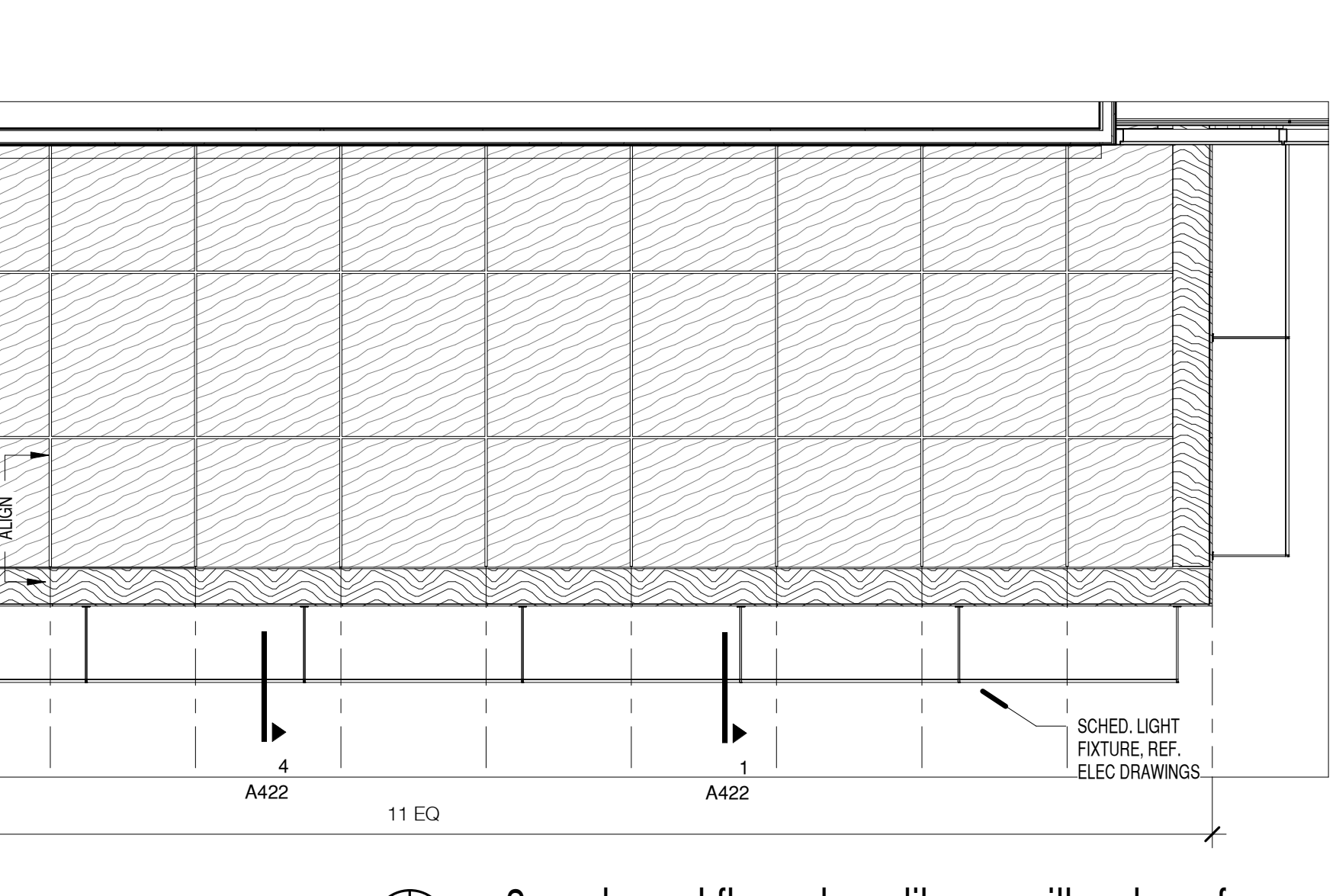

3 enlarged floor plan - library millwork roof
A102.1 SCALE: 1/4" = 1'-0"

1 second floor plan area A
A102.1 SCALE: 1/8" = 1'-0"

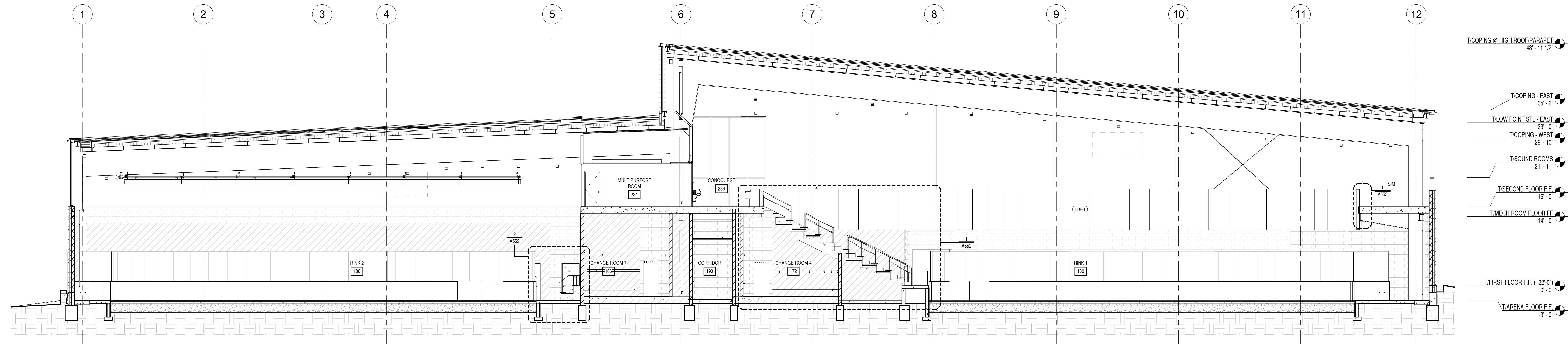

3 east/west building section - area B & C
 A350 SCALE: 1/8" = 1'-0"

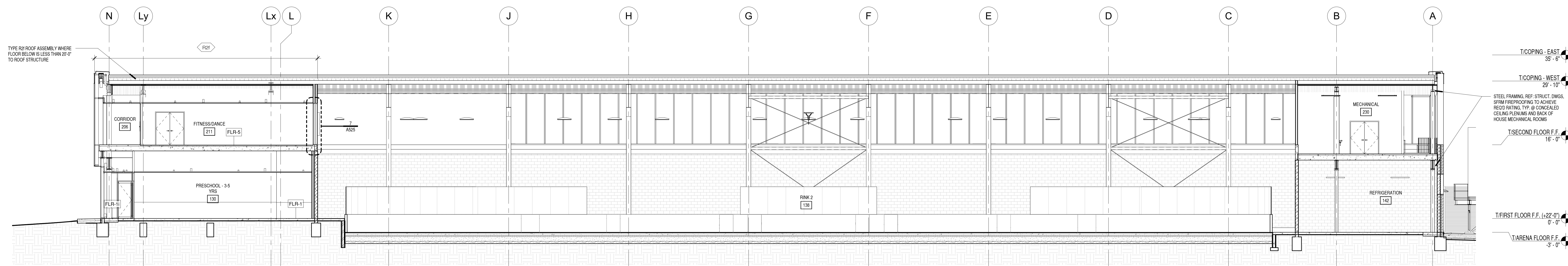

2 north/south building section - area C
 A350 SCALE: 1/8" = 1'-0"

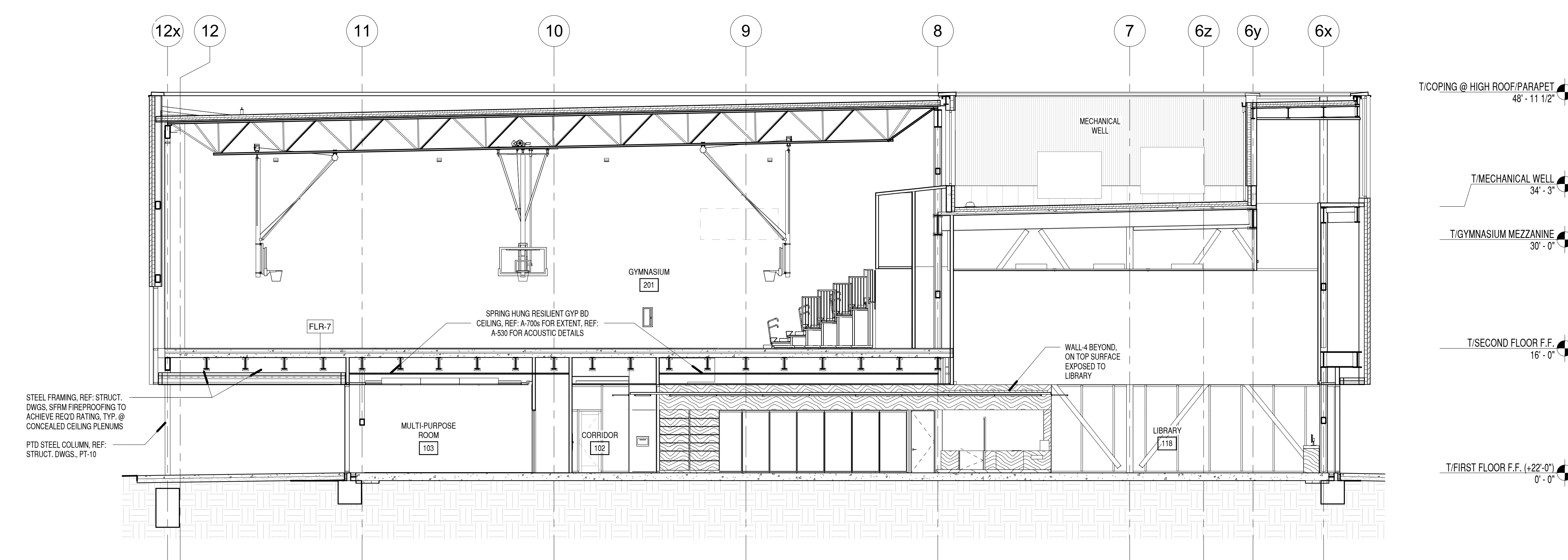

1 east/west section
 A350 SCALE: 1/8" = 1'-0"

project team

owner:
 City of Evanston
 2100 Ridge Ave
 Evanston, IL 60201
 847.448.8043

construction manager:
 Bully & Andrews
 1755 W. Armitage Ave.
 Chicago, IL 60622
 773.235.2433

structural engineer:
 Stearn-Joglekar, Ltd.
 223 W. Jackson Blvd., Suite 1110
 Chicago, IL 60606
 312.461.1800

MEP engineer (EOR, E/P/F/P)
 CCJM Engineers, Ltd.
 303 East Wacker Dr, Suite 303
 Chicago, IL 60601
 312.626.2977

MEP engineer (HVAC / Refrigeration)
 Smith+Andersen
 4211 Yonge Street Suite 500
 Toronto Ontario M2P 2A9
 416.487.8151

civil engineer / surveyor
 TERRA Engineering, Ltd
 225 W. Ohio St., 4th Floor
 Chicago, IL 60654
 312.457.9123

landscape architect
 Conservation Design Forum
 403 West St., Charles Road
 Lombard, IL 60148
 630.559.2000

sportsfield consultant:
 Jeffrey L. Bruce & Company
 1907 Swift Street, Suite 204
 North Kansas City, MO 64116
 816.842.8999

acoustics / audio visual:
 Anup
 35 E Upper Wacker Dr #1800
 Chicago, IL 60601
 312.849.5610

lighting design:
 Anne Kustner Lighting Design
 517 4th Street
 Waumette, IL 60091
 847.475.2010

commissioning agent:
 Grumman/Bulius Associates
 820 Davis Street, Suite 300
 Evanston, IL 60201
 847.328.3555

Woodhouse Tinucci Architects
 230 W Superior 6th Flr Chicago IL 60654
 Tel 312 943 3120 www.woodtinarch.com

MJMA
 6-425 Adelaide Street West
 Toronto Ontario M5V 3C1
 416.593.0708
 mjmaarchitects.com

© copyright 2020
**Robert Crown
 Community Center**
 1801 Main Street,
 Evanston, IL 60202

building sections
A350

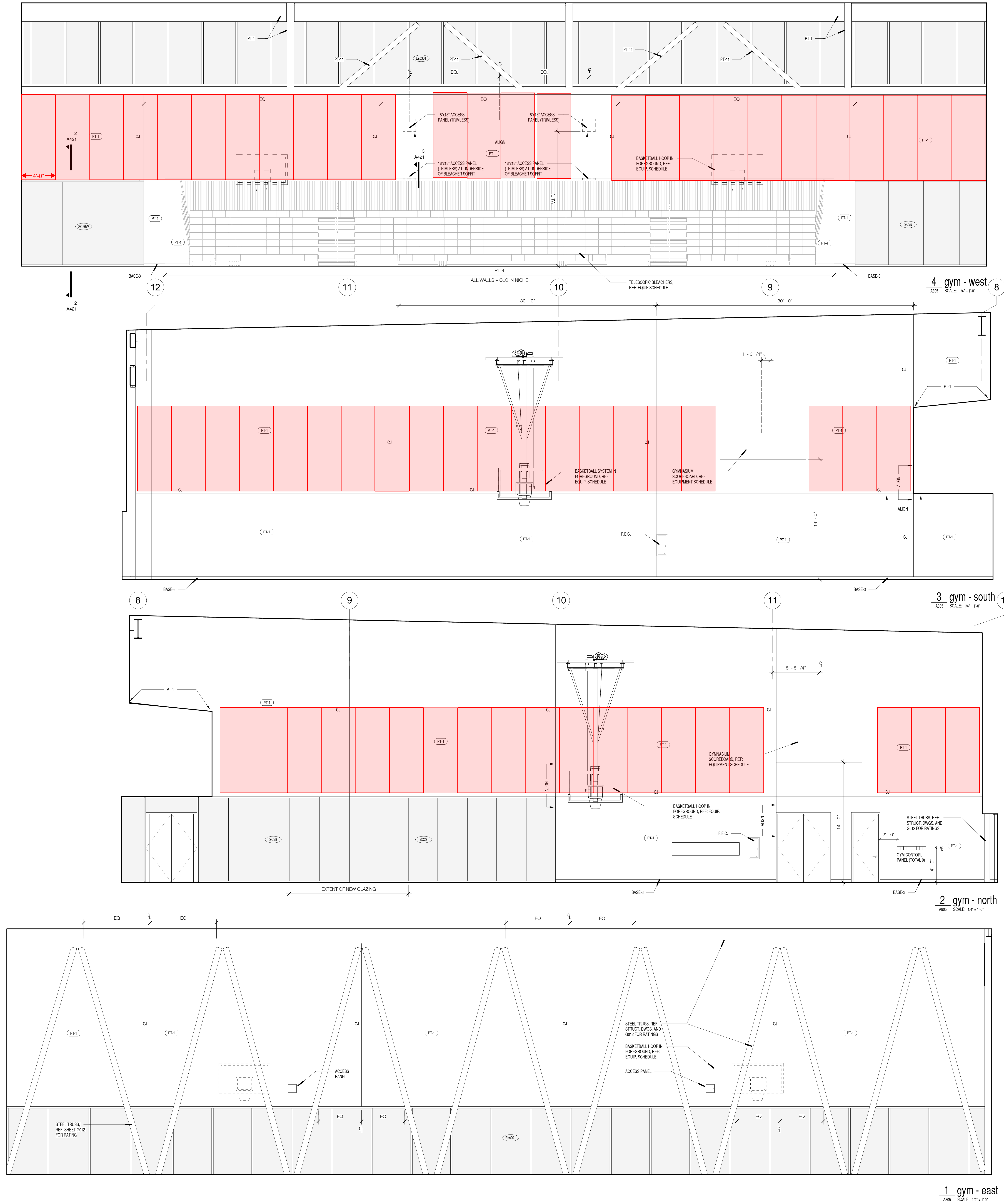

ISSUE

record drawing set	08.28.20
ASK-001 gym access panel coord.	01.17.20
ASK-002 multipurpose room 202	11.01.19
ASK-041 paint coordination	09.25.19
ASK-035 equip. controls coordination	07.15.19
ASK-033 finishes coordination	06.27.19
issued for construction	01.23.19
issued for permit	10.19.18
GMP Addendum #1	6.13.18
GMP	5.24.18
100% DD	4.6.18

NOTES

- project team
- owner: City of Evanston, 2100 Ridge Ave, Evanston, IL 60201, 847.448.8043
 - construction manager: Bully & Andrews, 1755 W. Armitage Ave., Chicago, IL 60622, 773.235.2433
 - structural engineer: Steam-Joglekar, Ltd., 223 W. Jackson Blvd., Suite 1110, Chicago, IL 60606, 312.461.1800
 - MEP engineer (EOR, E/P/FP): CCJM Engineers, Ltd., 303 East Wacker Dr., Suite 303, Chicago, IL 60601, 312.626.2977
 - MEP engineer (HVAC / Refrigeration): Smith+Andersen, 4211 Yonge Street Suite 500, Toronto Ontario M2P 2A9, 416.487.8151
 - civil engineer / surveyor: TERRA Engineering, Ltd., 225 W. Ohio St., 4th Floor, Chicago, IL 60654, 312.457.9123
 - landscape architect: Conservation Design Forum, 403 West St., Charles Road, Lombard, IL 60148, 630.559.2000
 - sportsfield consultant: Jeffrey L. Bruce & Company, 1907 Swift Street, Suite 204, North Kansas City, MO 64116, 816.842.8999
 - acoustics / audio visual: Anup, 35 E Upper Wacker Dr #1800, Chicago, IL 60601, 312.849.5610
 - lighting design: Anne Kustner Lighting Design, 517 4th Street, Wilmotte, IL 60091, 847.475.2010
 - commissioning agent: Grumman/Burkus Associates, 820 Davis Street, Suite 300, Evanston, IL 60201, 847.328.3555
- Woodhouse Tinucci Architects
230 W Superior 6th Flr Chicago IL 60654
Tel 312 943 3120 www.woodtinarch.com
- MJMA**
6-425 Adelaide Street West
Toronto Ontario M5V 3C1
416.593.0708
mjmaarchitects.com

© copyright 2020
**Robert Crown
Community Center**
1801 Main Street,
Evanston, IL 60202

interior elevations
A805



Fabric Panels

ACOUSTICAL WALL & CEILING PANELS

Acoustical Wall and Ceiling Panels by are designed to solve your acoustical needs while enhancing the aesthetic look of your space. With a variety of options to choose from including sizes, shapes, fabrics and colors it is easy to create the perfect solution for your reverberation sound problems.

The Fabric Standard Wall Panel provides the ultimate in acoustical performance with excellent NRC ratings as high as 1.15. They are available in four standard thicknesses: 1/2", 1", 1-1/2" and 2" with custom thickness available up to 4". The Fabric Panels are constructed with a 6-7# PCF rigid fiberglass absorber core. The edges are available in natural or chemically hardened and are available in 4 edge profiles. Fabric panels are available in standard or custom-sizes (up to a maximum of 5' X10') with custom, designer or C.O.M fabric available.

- High-quality, economical, multi-purpose panels
- Excellent acoustical performance
- Class A fire rated
- Standard, designer or C.O.M fabric
- Various mounting options
- Custom sizes and shapes

Applications:

- Schools / Universities
- Auditoriums
- Houses of worship
- Office spaces
- Theaters / Studios
- Multi-Purpose rooms
- Conference Rooms

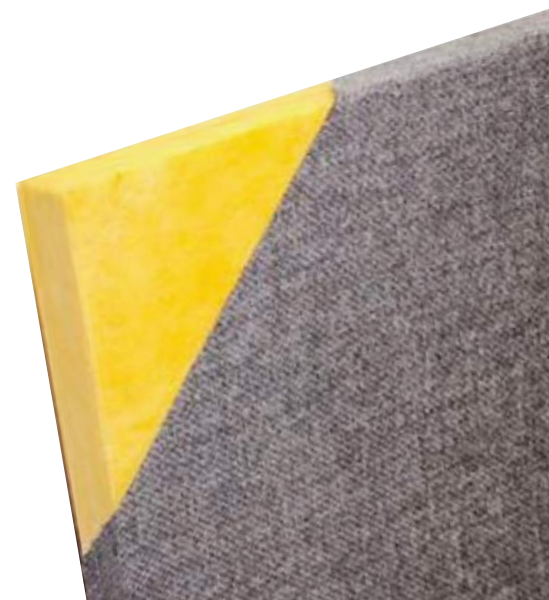



Fabric Panels

ACOUSTICAL WALL & CEILING PANELS

SPEC DATA SHEET **SQ-101**



FINISHES

Guilford of Maine FR701 Fabric Panel styles are the industry standard. Hundreds of approved decorative fabrics are also available from numerous manufacturers including, but not limited to: Guilford of Maine, Maharam, Design Tex and Knoll. Customers may also specify their own fabric, provided the material meets manufacturing requirements.

ACOUSTICAL

NRC Rating

1/2" Thick	.50 - .60
1" Thick	.80 - .90
1-1/2" Thick	.90 - 1.00
2" Thick	1.05 - 1.15

SIZING

All panels are custom made with standard sizes up to 4' x 10' and custom sizes up to 5' x 10', with thickness ranging from 1/2" - 4" thick

SPECIFICATIONS

Specifications can be downloaded from our website www.controlnoise.com or call us at 800 638-9355

MOUNTING OPTIONS



2-Part
Mechanical Clips



Rotofast Anchors



Impaling Clip

EDGE DETAILS

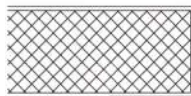

Square

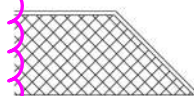

Miter



Bevel

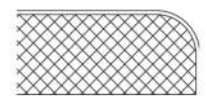

Radius

1. LAY OUT THE PANEL LOCATION(S) ON THE WALL.
NOTE: PANEL NEEDS APPROX 1" GAP @ TOP TO ALLOW ENGAGEMENT OF EC-CLIPS.

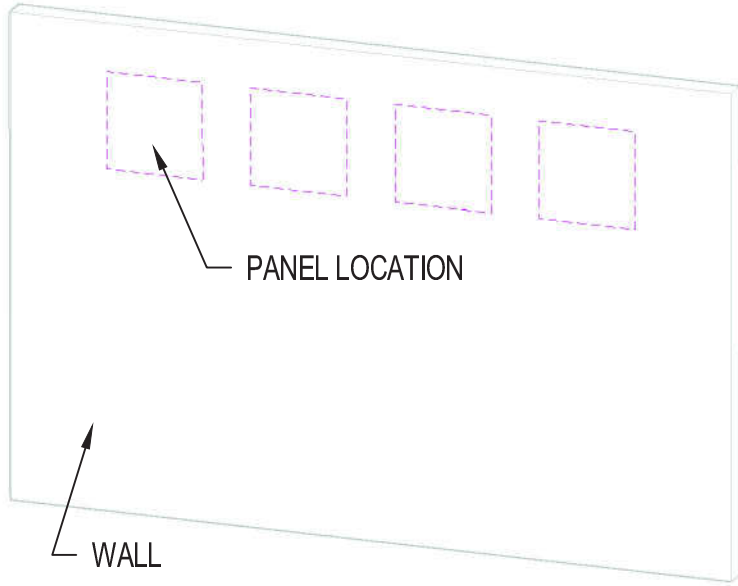

2. DETERMINE EC-2 / EC-4 BRACKET LOCATIONS ON WALL, BRACKETS SHOULD LINE UP WITH EC-1 CLIPS ON SUPPLIED PANELS.

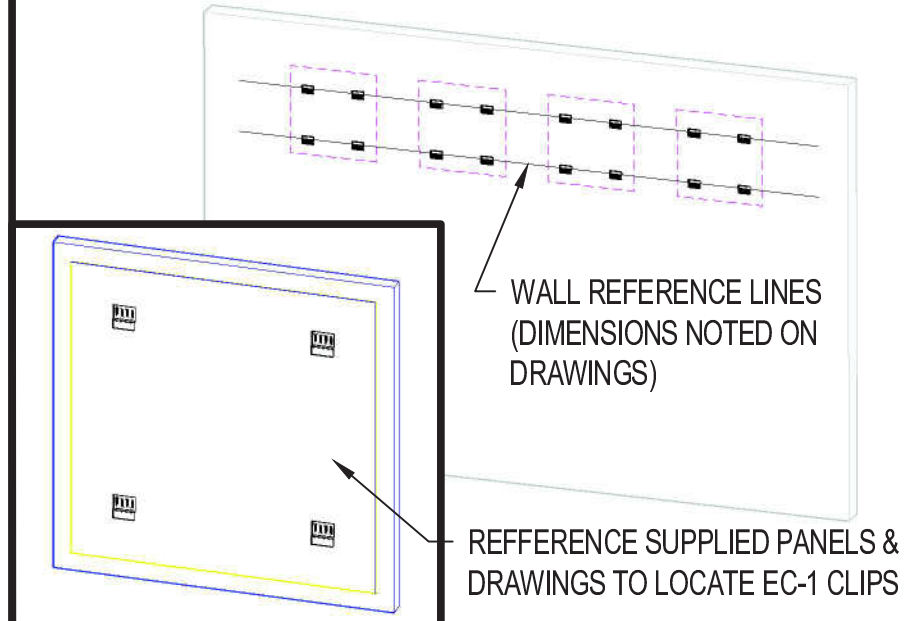

3. SECURE THE EC-2 / EC-4 BRACKETS TO THE WALL WITH SCREWS.

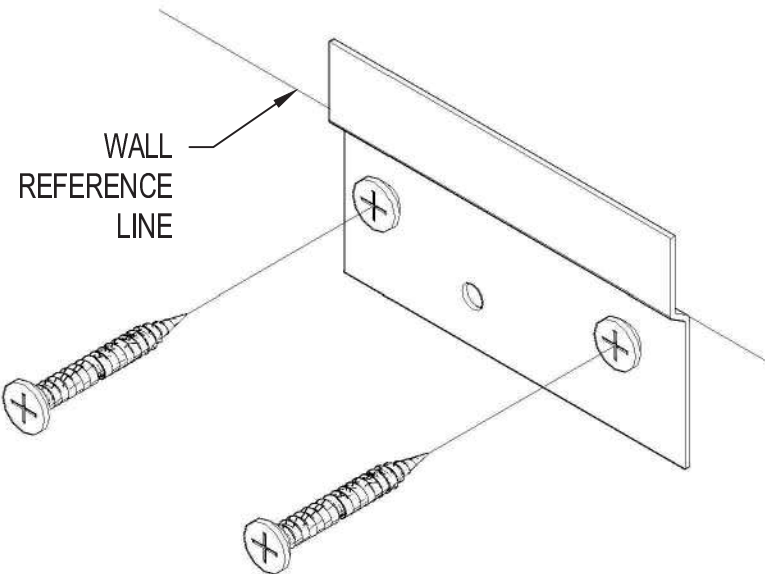

4. SLIDE THE EC-1 CLIPS ATTACHED TO THE PANEL ONTO THE EC-2 / EC-4 BRACKETS ON THE WALL.

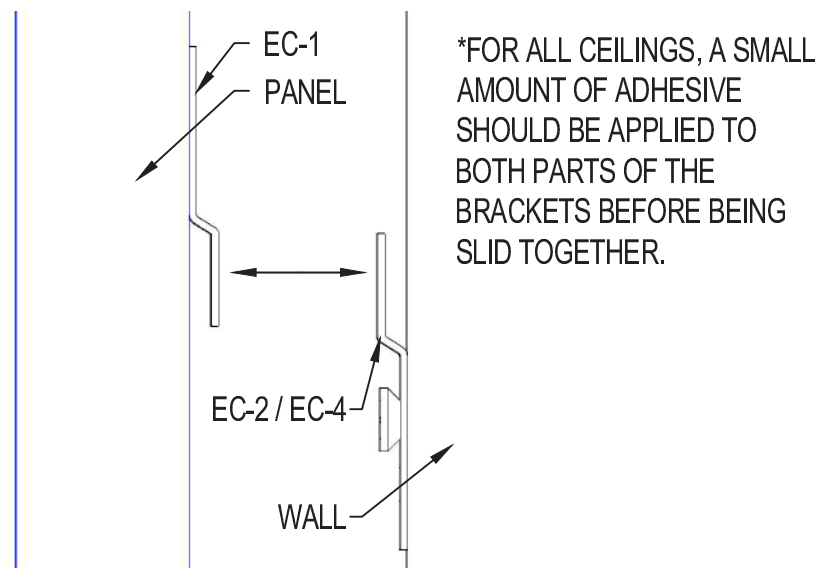

NETWELL NOISE CONTROL



3800 American Blvd W.

Bloomington, MN 55431

WWW.CONTROLNOISE.COM

(800) 638-9355

EC-CLIP
MOUNTING DETAIL

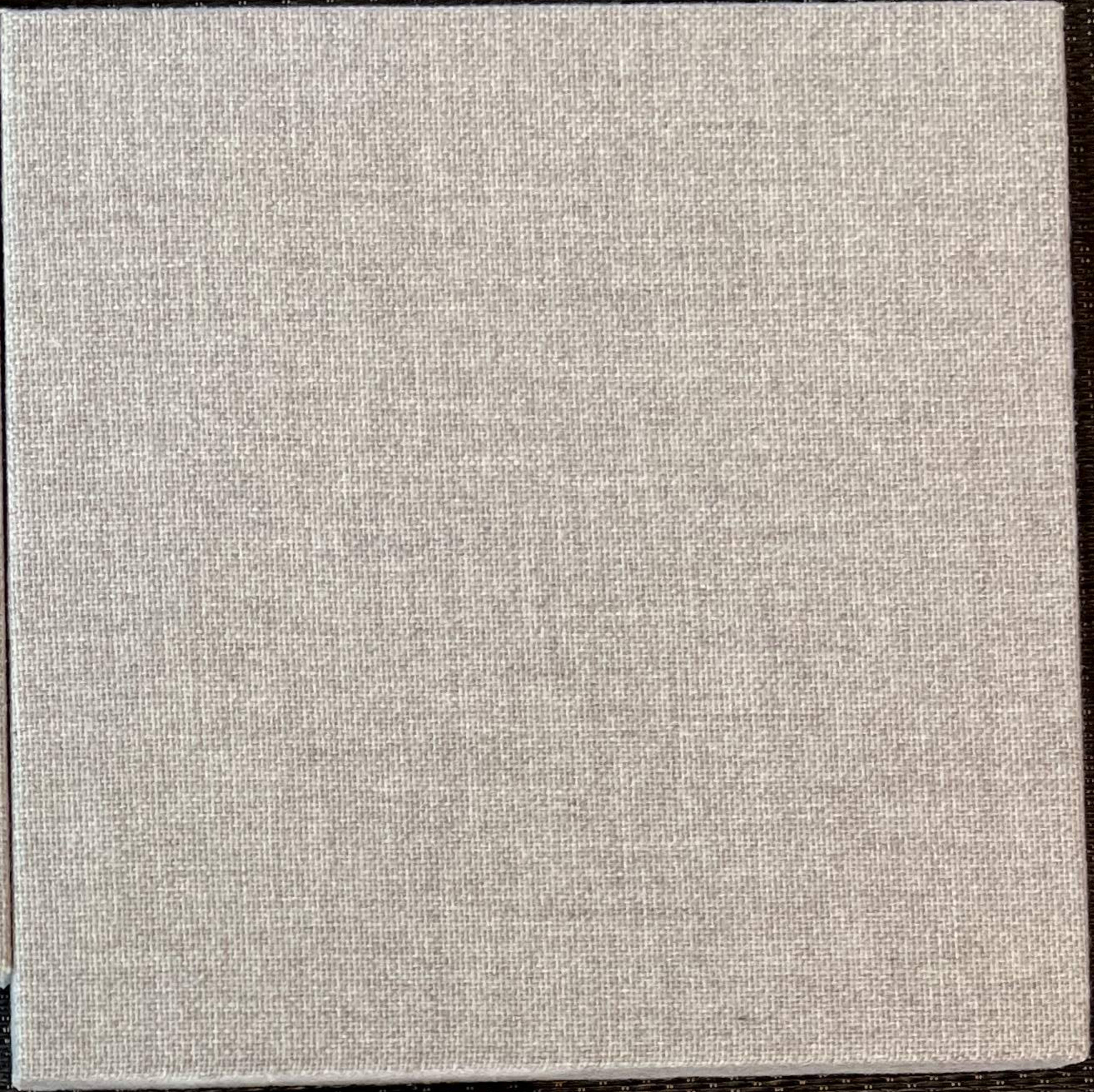
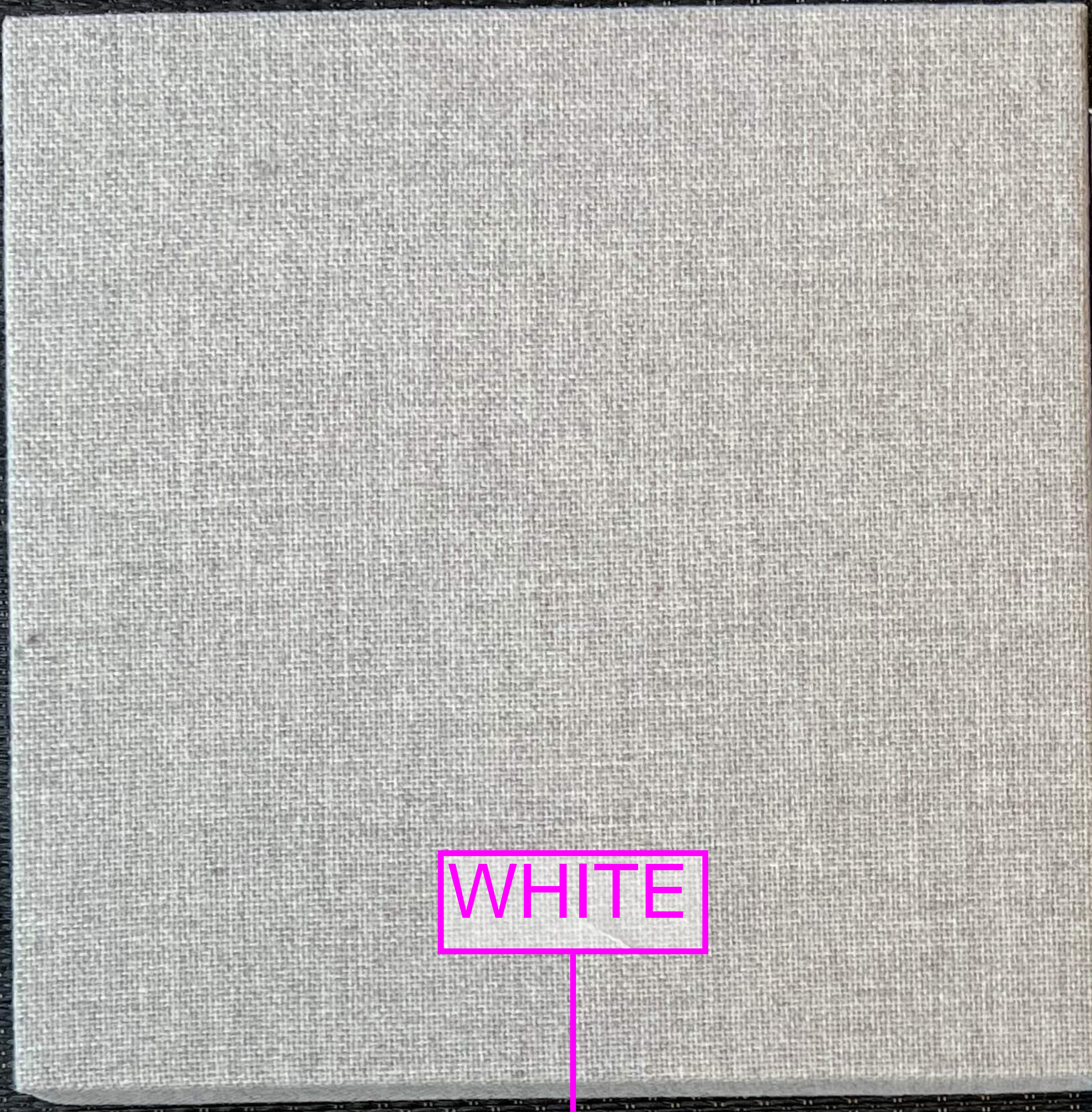

WHITE



JCLicht

Rosen/Five Star Dec

DATE: 09/12/19
 ESTIMATOR: Anthony Neumann
 JOB NAME: RCCC
 PRODUCT: Benjamin Moore HP29 Series
 DESCRIPTION: Ultra Spec DTM Acrylic Semi-Gloss
 COLOR: BM OC-149 Decorators White
 LOCATION: P-Arena Steel/Sprinkler Pipes



Bleach Cleanable

FR7010 2100
 White 224

JCLicht

Rosen/Five Star Dec

DATE: 09/12/19
 ESTIMATOR: Anthony Neumann
 JOB NAME: RCCC
 PRODUCT: Benjamin Moore V342 Series
 DESCRIPTION: Corotech Precat WB Epoxy Eggshell
 COLOR: BM 1591 Sterling
 LOCATION: P-Arena Back Of House Walls/Ceilings



Bleach Cleanable

FR7010 2100
 Dark 218

Bleach Cleanable

FR7010 2100
 Silver Paper 538





JCLicht

Rosen/Five Star Dec

DATE: 09/12/19
ESTIMATOR: Anthony Neumann
JOB NAME: RCDC
PRODUCT: Benjamin Moore HF29 Series
DESCRIPTION: Ultra Spec DTM Acrylic Semi-Gloss
COLOR: BM OC-149 Decorators White
LOCATION: P-Arena Steel/Sprinkler Pipes

JCLicht

Rosen/Five Star Dec

DATE: 09/12/19
ESTIMATOR: Anthony Neumann
JOB NAME: RCDC
PRODUCT: Benjamin Moore V342 Series
DESCRIPTION: Carotech Precoat WB Epoxy Eggshell
COLOR: BM 1591 Sterling
LOCATION: P-Arena Back Of House Walls/Ceilings



Bleach Cleanable
FR701® 2100
Silver Paper 538

Bleach Cleanable

FR701® 2100
White 224

Bleach Cleanable

FR701® 2100
Coin 794



Cook County Prevailing Wage Rates posted on 12/1/2022

Trade Title	Rg	Type	C	Base	Foreman	Overtime				H/W	Pension	Vac	Trng	Other Ins
						M-F	Sa	Su	Hol					
ASBESTOS ABT-GEN	All	ALL		47.40	48.40	1.5	1.5	2.0	2.0	17.05	15.21	0.00	0.90	
ASBESTOS ABT-MEC	All	BLD		39.60	42.77	1.5	1.5	2.0	2.0	14.77	13.59	0.00	0.86	
BOILERMAKER	All	BLD		53.66	58.48	2.0	2.0	2.0	2.0	6.97	23.69	0.00	2.67	
BRICK MASON	All	BLD		49.81	54.79	1.5	1.5	2.0	2.0	12.10	21.56	0.00	1.10	
CARPENTER	All	ALL		52.01	54.01	1.5	1.5	2.0	2.0	11.79	24.76	1.50	0.80	
CEMENT MASON	All	ALL		49.75	51.75	2.0	1.5	2.0	2.0	17.08	20.74	0.00	1.00	
CERAMIC TILE FINISHER	All	BLD		44.18	44.18	1.5	1.5	2.0	2.0	12.25	14.77	0.00	1.00	
CERAMIC TILE LAYER	All	BLD		51.44	55.44	1.5	1.5	2.0	2.0	12.25	18.48	0.00	1.08	
COMMUNICATION ELECTRICIAN	All	BLD		47.16	50.46	1.5	1.5	2.0	2.0	12.70	14.10	1.25	1.57	0.50
ELECTRIC PWR EQMT OP	All	ALL		58.25	63.91	1.5	1.5	2.0	2.0	13.08	19.67	0.00	3.19	
ELECTRIC PWR GRNDMAN	All	ALL		45.44	63.91	1.5	1.5	2.0	2.0	10.20	15.34	0.00	2.49	
ELECTRIC PWR LINEMAN	All	ALL		58.25	63.91	1.5	1.5	2.0	2.0	13.08	19.67	0.00	3.19	
ELECTRICIAN	All	ALL		52.05	55.69	1.5	1.5	2.0	2.0	17.65	18.30	1.25	1.92	1.50
ELEVATOR CONSTRUCTOR	All	BLD		62.47	70.28	2.0	2.0	2.0	2.0	16.03	20.21	5.00	0.65	
FENCE ERECTOR	All	ALL		46.89	48.89	1.5	1.5	2.0	2.0	13.68	17.42	0.00	0.75	
GLAZIER	All	BLD		48.75	50.25	1.5	2.0	2.0	2.0	15.19	24.43	0.00	1.70	
HEAT/FROST INSULATOR	All	BLD		52.80	55.97	1.5	1.5	2.0	2.0	14.77	16.76	0.00	0.86	
IRON WORKER	All	ALL		55.81	57.81	2.0	2.0	2.0	2.0	16.05	25.31	0.00	0.49	
LABORER	All	ALL		47.40	48.15	1.5	1.5	2.0	2.0	17.05	15.21	0.00	0.90	
LATHER	All	ALL		52.01	54.01	1.5	1.5	2.0	2.0	11.79	24.76	1.50	0.80	
MACHINIST	All	BLD		53.18	57.18	1.5	1.5	2.0	2.0	9.93	8.95	1.85	1.47	
MARBLE FINISHER	All	ALL		38.00	51.41	1.5	1.5	2.0	2.0	12.10	19.60	0.00	0.60	
MARBLE SETTER	All	BLD		48.96	53.86	1.5	1.5	2.0	2.0	12.10	21.03	0.00	0.78	
MATERIAL TESTER I	All	ALL		37.40		1.5	1.5	2.0	2.0	17.05	15.21	0.00	0.90	
MATERIALS TESTER II	All	ALL		42.40		1.5	1.5	2.0	2.0	17.05	15.21	0.00	0.90	
MILLWRIGHT	All	ALL		52.01	54.01	1.5	1.5	2.0	2.0	11.79	24.76	1.50	0.80	
OPERATING ENGINEER	All	BLD	1	55.10	59.10	2.0	2.0	2.0	2.0	22.15	19.30	2.00	2.55	
OPERATING ENGINEER	All	BLD	2	53.80	59.10	2.0	2.0	2.0	2.0	22.15	19.30	2.00	2.55	
OPERATING ENGINEER	All	BLD	3	51.25	59.10	2.0	2.0	2.0	2.0	22.15	19.30	2.00	2.55	
OPERATING ENGINEER	All	BLD	4	49.50	59.10	2.0	2.0	2.0	2.0	22.15	19.30	2.00	2.55	
OPERATING ENGINEER	All	BLD	5	58.85	59.10	2.0	2.0	2.0	2.0	22.15	19.30	2.00	2.55	

OPERATING ENGINEER	All	BLD	6	56.10	59.10	2.0	2.0	2.0	2.0	22.15	19.30	2.00	2.55
OPERATING ENGINEER	All	BLD	7	58.10	59.10	2.0	2.0	2.0	2.0	22.15	19.30	2.00	2.55
OPERATING ENGINEER	All	FLT	1	61.10	61.10	1.5	1.5	2.0	2.0	21.40	18.60	2.00	2.40
OPERATING ENGINEER	All	FLT	2	59.60	61.10	1.5	1.5	2.0	2.0	21.40	18.60	2.00	2.40
OPERATING ENGINEER	All	FLT	3	58.10	61.10	1.5	1.5	2.0	2.0	21.40	18.60	2.00	2.40
OPERATING ENGINEER	All	FLT	4	53.60	61.10	1.5	1.5	2.0	2.0	21.40	18.60	2.00	2.40
OPERATING ENGINEER	All	FLT	5	62.60	61.10	1.5	1.5	2.0	2.0	21.40	18.60	2.00	2.40
OPERATING ENGINEER	All	FLT	6	41.00	61.10	1.5	1.5	2.0	2.0	21.40	18.60	2.00	2.40
OPERATING ENGINEER	All	HWY	1	53.30	57.30	1.5	1.5	2.0	2.0	22.15	19.30	2.00	2.55
OPERATING ENGINEER	All	HWY	2	52.75	57.30	1.5	1.5	2.0	2.0	22.15	19.30	2.00	2.55
OPERATING ENGINEER	All	HWY	3	50.70	57.30	1.5	1.5	2.0	2.0	22.15	19.30	2.00	2.55
OPERATING ENGINEER	All	HWY	4	49.30	57.30	1.5	1.5	2.0	2.0	22.15	19.30	2.00	2.55
OPERATING ENGINEER	All	HWY	5	48.10	57.30	1.5	1.5	2.0	2.0	22.15	19.30	2.00	2.55
OPERATING ENGINEER	All	HWY	6	56.30	57.30	1.5	1.5	2.0	2.0	22.15	19.30	2.00	2.55
OPERATING ENGINEER	All	HWY	7	54.30	57.30	1.5	1.5	2.0	2.0	22.15	19.30	2.00	2.55
ORNAMENTAL IRON WORKER	All	ALL		53.32	55.82	2.0	2.0	2.0	2.0	14.23	25.00	0.00	1.75
PAINTER	All	ALL		50.30	56.59	1.5	1.5	1.5	2.0	14.26	14.99	0.00	1.72
PAINTER - SIGNS	All	BLD		41.55	46.67	1.5	1.5	2.0	2.0	3.04	3.90	0.00	0.00
PILEDRIVER	All	ALL		52.01	54.01	1.5	1.5	2.0	2.0	11.79	24.76	1.50	0.80
PIPEFITTER	All	BLD		53.00	56.00	1.5	1.5	2.0	2.0	11.85	22.85	0.00	2.92
PLASTERER	All	BLD		47.75	50.62	1.5	1.5	2.0	2.0	17.08	19.18	0.00	1.00
PLUMBER	All	BLD		54.80	58.10	1.5	1.5	2.0	2.0	16.70	17.04	0.00	1.58
ROOFER	All	BLD		48.00	53.00	1.5	1.5	2.0	2.0	11.83	15.26	0.00	0.99
SHEETMETAL WORKER	All	BLD		49.10	53.03	1.5	1.5	2.0	2.0	13.53	28.20	0.00	1.00
SIGN HANGER	All	BLD		34.72	37.50	1.5	1.5	2.0	2.0	6.85	4.50	0.00	0.00
SPRINKLER FITTER	All	BLD		53.25	56.00	1.5	1.5	2.0	2.0	14.20	18.60	0.00	0.75
STEEL ERECTOR	All	ALL		55.81	57.81	2.0	2.0	2.0	2.0	16.05	25.31	0.00	0.49
STONE MASON	All	BLD		49.81	54.79	1.5	1.5	2.0	2.0	12.10	21.56	0.00	1.10
TERRAZZO FINISHER	All	BLD		45.57	45.57	1.5	1.5	2.0	2.0	12.25	17.14	0.00	1.03
TERRAZZO MECHANIC	All	BLD		49.41	52.91	1.5	1.5	2.0	2.0	12.25	18.60	0.00	1.07
TRAFFIC SAFETY WORKER I	All	HWY		39.30	40.90	1.5	1.5	2.0	2.0	9.65	9.10	0.00	0.10
TRAFFIC SAFETY WORKER II	All	HWY		40.30	41.90	1.5	1.5	2.0	2.0	9.65	9.10	0.00	0.10
TRUCK DRIVER	E	ALL	1	39.95	40.60	1.5	1.5	2.0	2.0	12.30	15.24	0.00	0.15
TRUCK DRIVER	E	ALL	2	40.20	40.60	1.5	1.5	2.0	2.0	12.30	15.24	0.00	0.15
TRUCK DRIVER	E	ALL	3	40.40	40.60	1.5	1.5	2.0	2.0	12.30	15.24	0.00	0.15
TRUCK DRIVER	E	ALL	4	40.60	40.60	1.5	1.5	2.0	2.0	12.30	15.24	0.00	0.15

TRUCK DRIVER	W	ALL	1	40.63	41.18	1.5	1.5	2.0	2.0	10.70	14.71	0.00	0.15	
TRUCK DRIVER	W	ALL	2	40.78	41.18	1.5	1.5	2.0	2.0	10.70	14.71	0.00	0.15	
TRUCK DRIVER	W	ALL	3	40.98	41.18	1.5	1.5	2.0	2.0	10.70	14.71	0.00	0.15	
TRUCK DRIVER	W	ALL	4	41.18	41.18	1.5	1.5	2.0	2.0	10.70	14.71	0.00	0.15	
TUCKPOINTER	All	BLD		49.53	50.53	1.5	1.5	2.0	2.0	9.04	21.06	0.00	1.07	

Legend

Rg Region

Type Trade Type - All,Highway,Building,Floating,Oil & Chip,Rivers

C Class

Base Base Wage Rate

OT M-F Unless otherwise noted, OT pay is required for any hour greater than 8 worked each day, Mon through Fri. The number listed is the multiple of the base wage.

OT Sa Overtime pay required for every hour worked on Saturdays

OT Su Overtime pay required for every hour worked on Sundays

OT Hol Overtime pay required for every hour worked on Holidays

H/W Health/Welfare benefit

Vac Vacation

Trng Training

Other Ins Employer hourly cost for any other type(s) of insurance provided for benefit of worker.

Explanations COOK COUNTY

The following list is considered as those days for which holiday rates of wages for work performed apply: New Years Day, Memorial Day, Fourth of July, Labor Day, Thanksgiving Day, Christmas Day and Veterans Day in some classifications/counties. Generally, any of these holidays which fall on a Sunday is celebrated on the following Monday. This then makes work performed on that Monday payable at the appropriate overtime rate for holiday pay. Common practice in a given local may alter certain days of celebration. If in doubt, please check with IDOL.

TRUCK DRIVERS (WEST) - That part of the county West of Barrington Road.

EXPLANATION OF CLASSES

ASBESTOS - GENERAL - removal of asbestos material/mold and hazardous materials from any place in a building, including mechanical systems where those mechanical systems are to be removed. This includes the removal of asbestos materials/mold and hazardous materials from ductwork or pipes in a building when the building is to be demolished at the time or at some close future date. ASBESTOS - MECHANICAL - removal of asbestos material from mechanical systems, such as pipes, ducts, and boilers, where the mechanical systems are to remain.

CERAMIC TILE FINISHER

The grouting, cleaning, and polishing of all classes of tile, whether for interior or exterior purposes, all burned, glazed or unglazed products; all composition materials, granite tiles, warning detectable tiles, cement tiles, epoxy composite materials, pavers, glass, mosaics, fiberglass, and all substitute materials, for tile made in tile-like units; all mixtures in tile like form of cement, metals, and other materials that are for and intended for use as a finished floor surface, stair treads, promenade roofs, walks, walls, ceilings, swimming pools, and all other places where tile is to form a finished interior or exterior. The mixing of all setting mortars including but not limited to thin-set mortars, epoxies, wall mud, and any other sand and cement mixtures or adhesives when

used in the preparation, installation, repair, or maintenance of tile and/or similar materials. The handling and unloading of all sand, cement, lime, tile, fixtures, equipment, adhesives, or any other materials to be used in the preparation, installation, repair, or maintenance of tile and/or similar materials. Ceramic Tile Finishers shall fill all joints and voids regardless of method on all tile work, particularly and especially after installation of said tile work. Application of any and all protective coverings to all types of tile installations including, but not be limited to, all soap compounds, paper products, tapes, and all polyethylene coverings, plywood, masonite, cardboard, and any new type of products that may be used to protect tile installations, Blastrac equipment, and all floor scarifying equipment used in preparing floors to receive tile. The clean up and removal of all waste and materials. All demolition of existing tile floors and walls to be re-tiled.

COMMUNICATIONS ELECTRICIAN

Installation, operation, inspection, maintenance, repair and service of radio, television, recording, voice sound vision production and reproduction, telephone and telephone interconnect, facsimile, data apparatus, coaxial, fibre optic and wireless equipment, appliances and systems used for the transmission and reception of signals of any nature, business, domestic, commercial, education, entertainment, and residential purposes, including but not limited to, communication and telephone, electronic and sound equipment, fibre optic and data communication systems, and the performance of any task directly related to such installation or service whether at new or existing sites, such tasks to include the placing of wire and cable and electrical power conduit or other raceway work within the equipment room and pulling wire and/or cable through conduit and the installation of any incidental conduit, such that the employees covered hereby can complete any job in full.

MARBLE FINISHER

Loading and unloading trucks, distribution of all materials (all stone, sand, etc.), stocking of floors with material, performing all rigging for heavy work, the handling of all material that may be needed for the installation of such materials, building of scaffolding, polishing if needed, patching, waxing of material if damaged, pointing up, caulking, grouting and cleaning of marble, holding water on diamond or Carborundum blade or saw for setters cutting, use of tub saw or any other saw needed for preparation of material, drilling of holes for wires that anchor material set by setters, mixing up of molding plaster for installation of material, mixing up thin set for the installation of material, mixing up of sand to cement for the installation of material and such other work as may be required in helping a Marble Setter in the handling of all material in the erection or installation of interior marble, slate, travertine, art marble, serpentine, alberene stone, blue stone, granite and other stones (meaning as to stone any foreign or domestic materials as are specified and used in building interiors and exteriors and customarily known as stone in the trade), carrara, sanionyx, vitrolite and similar opaque glass and the laying of all marble tile, terrazzo tile, slate tile and precast tile, steps, risers treads, base, or any other materials that may be used as substitutes for any of the aforementioned materials and which are used on interior and exterior which are installed in a similar manner.

MATERIAL TESTER I: Hand coring and drilling for testing of materials; field inspection of uncured concrete and asphalt.

MATERIAL TESTER II: Field inspection of welds, structural steel, fireproofing, masonry, soil, facade, reinforcing steel, formwork, cured concrete, and concrete and asphalt batch plants; adjusting proportions of bituminous mixtures.

OPERATING ENGINEER - BUILDING

Class 1. Asphalt Plant; Asphalt Spreader; Autograde; Backhoes with Caisson Attachment; Batch Plant; Benoto (requires Two Engineers); Boiler and Throttle Valve; Caisson Rigs; Central Redi-Mix Plant; Combination Back Hoe Front End-loader Machine; Compressor and Throttle Valve; Concrete Breaker (Truck Mounted); Concrete Conveyor; Concrete Conveyor (Truck Mounted); Concrete Paver Over 27E cu. ft; Concrete Paver 27E cu. ft. and Under; Concrete Placer; Concrete Placing Boom; Concrete Pump (Truck Mounted); Concrete Tower; Cranes, All; Cranes, Hammerhead; Cranes, (GCI and similar Type); Creter Crane; Spider Crane; Crusher, Stone, etc.; Derricks, All; Derricks, Traveling; Formless Curb and Gutter Machine; Grader, Elevating; Grouting Machines; Heavy Duty Self-Propelled Transporter or Prime Mover; Highlift Shovels or Front Endloader 2-1/4 yd. and over; Hoists, Elevators, outside type rack and pinion and similar machines; Hoists, One, Two and Three Drum; Hoists, Two Tugger One Floor; Hydraulic

Backhoes; Hydraulic Boom Trucks; Hydro Vac (and similar equipment); Locomotives, All; Motor Patrol; Lubrication Technician; Manipulators; Pile Drivers and Skid Rig; Post Hole Digger; Pre-Stress Machine; Pump Cretes Dual Ram; Pump Cretes: Squeeze Cretes-Screw Type Pumps; Gypsum Bulker and Pump; Raised and Blind Hole Drill; Roto Mill Grinder; Scoops - Tractor Drawn; Slip-Form Paver; Straddle Buggies; Operation of Tie Back Machine; Tournapull; Tractor with Boom and Side Boom; Trenching Machines.

Class 2. Boilers; Broom, All Power Propelled; Bulldozers; Concrete Mixer (Two Bag and Over); Conveyor, Portable; Forklift Trucks; Highlift Shovels or Front Endloaders under 2-1/4 yd.; Hoists, Automatic; Hoists, Inside Elevators; Hoists, Sewer Dragging Machine; Hoists, Tugger Single Drum; Laser Screed; Rock Drill (Self-Propelled); Rock Drill (Truck Mounted); Rollers, All; Steam Generators; Tractors, All; Tractor Drawn Vibratory Roller; Winch Trucks with "A" Frame.

Class 3. Air Compressor; Combination Small Equipment Operator; Generators; Heaters, Mechanical; Hoists, Inside Elevators (remodeling or renovation work); Hydraulic Power Units (Pile Driving, Extracting, and Drilling); Pumps, over 3" (1 to 3 not to exceed a total of 300 ft.); Low Boys; Pumps, Well Points; Welding Machines (2 through 5); Winches, 4 Small Electric Drill Winches.

Class 4. Bobcats and/or other Skid Steer Loaders; Oilers; and Brick Forklift.

Class 5. Assistant Craft Foreman.

Class 6. Gradall.

Class 7. Mechanics; Welders.

OPERATING ENGINEERS - HIGHWAY CONSTRUCTION

Class 1. Asphalt Plant; Asphalt Heater and Planer Combination; Asphalt Heater Scarfire; Asphalt Spreader; Autograder/GOMACO or other similar type machines: ABG Paver; Backhoes with Caisson Attachment; Ballast Regulator; Belt Loader; Caisson Rigs; Car Dumper; Central Redi-Mix Plant; Combination Backhoe Front Endloader Machine, (1 cu. yd. Backhoe Bucket or over or with attachments); Concrete Breaker (Truck Mounted); Concrete Conveyor; Concrete Paver over 27E cu. ft.; Concrete Placer; Concrete Tube Float; Cranes, all attachments; Cranes, Tower Cranes of all types: Creter Crane: Spider Crane; Crusher, Stone, etc.; Derricks, All; Derrick Boats; Derricks, Traveling; Dredges; Elevators, Outside type Rack & Pinion and Similar Machines; Formless Curb and Gutter Machine; Grader, Elevating; Grader, Motor Grader, Motor Patrol, Auto Patrol, Form Grader, Pull Grader, Subgrader; Guard Rail Post Driver Truck Mounted; Hoists, One, Two and Three Drum; Heavy Duty Self-Propelled Transporter or Prime Mover; Hydraulic Backhoes; Backhoes with shear attachments up to 40' of boom reach; Lubrication Technician; Manipulators; Mucking Machine; Pile Drivers and Skid Rig; Pre-Stress Machine; Pump Cretes Dual Ram; Rock Drill - Crawler or Skid Rig; Rock Drill - Truck Mounted; Rock/Track Tamper; Roto Mill Grinder; Slip-Form Paver; Snow Melters; Soil Test Drill Rig (Truck Mounted); Straddle Buggies; Hydraulic Telescoping Form (Tunnel); Operation of Tieback Machine; Tractor Drawn Belt Loader; Tractor Drawn Belt Loader (with attached pusher - two engineers); Tractor with Boom; Tractaire with Attachments; Traffic Barrier Transfer Machine; Trenching; Truck Mounted Concrete Pump with Boom; Raised or Blind Hole Drills (Tunnel Shaft); Underground Boring and/or Mining Machines 5 ft. in diameter and over tunnel, etc; Underground Boring and/or Mining Machines under 5 ft. in diameter; Wheel Excavator; Widener (APSCO).

Class 2. Batch Plant; Bituminous Mixer; Boiler and Throttle Valve; Bulldozers; Car Loader Trailing Conveyors; Combination Backhoe Front Endloader Machine (Less than 1 cu. yd. Backhoe Bucket or over or with attachments); Compressor and Throttle Valve; Compressor, Common Receiver (3); Concrete Breaker or Hydro Hammer; Concrete Grinding Machine; Concrete Mixer or Paver 7S Series to and including 27 cu. ft.; Concrete Spreader; Concrete Curing Machine, Burlap Machine, Belting Machine and Sealing Machine; Concrete Wheel Saw; Conveyor Muck Cars (Haglund or Similar Type); Drills, All; Finishing Machine - Concrete; Highlift Shovels or Front Endloader; Hoist - Sewer Dragging Machine; Hydraulic Boom Trucks (All Attachments); Hydro-Blaster; Hydro Excavating (excluding hose work); Laser Screed; All Locomotives, Dinky; Off-Road Hauling Units (including articulating) Non Self-Loading Ejection Dump; Pump Cretes: Squeeze Cretes - Screw Type Pumps, Gypsum Bulker and Pump; Roller, Asphalt; Rotary

Snow Plows; Rototiller, Seaman, etc., self-propelled; Self-Propelled Compactor; Spreader - Chip - Stone, etc.; Scraper - Single/Twin Engine/Push and Pull; Scraper - Prime Mover in Tandem (Regardless of Size); Tractors pulling attachments, Sheeps Foot, Disc, Compactor, etc.; Tug Boats.

Class 3. Boilers; Brooms, All Power Propelled; Cement Supply Tender; Compressor, Common Receiver (2); Concrete Mixer (Two Bag and Over); Conveyor, Portable; Farm-Type Tractors Used for Mowing, Seeding, etc.; Forklift Trucks; Grouting Machine; Hoists, Automatic; Hoists, All Elevators; Hoists, Tugger Single Drum; Jeep Diggers; Low Boys; Pipe Jacking Machines; Post-Hole Digger; Power Saw, Concrete Power Driven; Pug Mills; Rollers, other than Asphalt; Seed and Straw Blower; Steam Generators; Stump Machine; Winch Trucks with "A" Frame; Work Boats; Tamper-Form-Motor Driven.

Class 4. Air Compressor; Combination - Small Equipment Operator; Directional Boring Machine; Generators; Heaters, Mechanical; Hydraulic Power Unit (Pile Driving, Extracting, or Drilling); Light Plants, All (1 through 5); Pumps, over 3" (1 to 3 not to exceed a total of 300 ft.); Pumps, Well Points; Vacuum Trucks (excluding hose work); Welding Machines (2 through 5); Winches, 4 Small Electric Drill Winches.

Class 5. SkidSteer Loader (all); Brick Forklifts; Oilers.

Class 6. Field Mechanics and Field Welders

Class 7. Dowell Machine with Air Compressor; Gradall and machines of like nature.

OPERATING ENGINEER - FLOATING

Class 1. Craft Foreman; Master Mechanic; Diver/Wet Tender; Engineer; Engineer (Hydraulic Dredge).

Class 2. Crane/Backhoe Operator; Boat Operator with towing endorsement; Mechanic/Welder; Assistant Engineer (Hydraulic Dredge); Leverman (Hydraulic Dredge); Diver Tender.

Class 3. Deck Equipment Operator, Machineryman, Maintenance of Crane (over 50 ton capacity) or Backhoe (115,000 lbs. or more); Tug/Launch Operator; Loader/Dozer and like equipment on Barge, Breakwater Wall, Slip/Dock, or Scow, Deck Machinery, etc.

Class 4. Deck Equipment Operator, Machineryman/Fireman (4 Equipment Units or More); Off Road Trucks; Deck Hand, Tug Engineer, Crane Maintenance (50 Ton Capacity and Under) or Backhoe Weighing (115,000 pounds or less); Assistant Tug Operator.

Class 5. Friction or Lattice Boom Cranes.

Class 6. ROV Pilot, ROV Tender

TERRAZZO FINISHER

The handling of sand, cement, marble chips, and all other materials that may be used by the Mosaic Terrazzo Mechanic, and the mixing, grinding, grouting, cleaning and sealing of all Marble, Mosaic, and Terrazzo work, floors, base, stairs, and wainscoting by hand or machine, and in addition, assisting and aiding Marble, Masonic, and Terrazzo Mechanics.

TRAFFIC SAFETY Worker I

Traffic Safety Worker I - work associated with the delivery, installation, pick-up and servicing of safety devices during periods of roadway construction, including such work as set-up and maintenance of barricades, barrier wall reflectors, drums, cones, delineators, signs, crash attenuators, glare screen and other such items, and the layout and application or removal of conflicting and/or temporary roadway markings utilized to control traffic in construction zones, as well as flagging for these operations.

TRAFFIC SAFETY WORKER II

Work associated with the installation and removal of permanent pavement markings and/or pavement markers including both installations performed by hand and installations performed by truck.

TRUCK DRIVER - BUILDING, HEAVY AND HIGHWAY CONSTRUCTION - EAST & WEST

Class 1. Two or three Axle Trucks. A-frame Truck when used for transportation purposes; Air Compressors and Welding Machines, including those pulled by cars, pick-up trucks and tractors; Ambulances; Batch Gate Lockers; Batch Hopperman; Car and Truck Washers; Carry-alls; Fork Lifts and Hoisters; Helpers; Mechanics Helpers and Greasers; Oil Distributors 2-man operation; Pavement Breakers; Pole Trailer, up to 40 feet; Power Mower Tractors; Self-propelled Chip Spreader; Skipman; Slurry Trucks, 2-man operation; Slurry Truck Conveyor Operation, 2 or 3 man; Teamsters; Unskilled Dumpman; and Truck Drivers hauling warning lights, barricades, and portable toilets on the job site.

Class 2. Four axle trucks; Dump Crets and Adgetors under 7 yards; Dumpsters, Track Trucks, Euclids, Hug Bottom Dump Turnapulls or Turntrailers when pulling other than self-loading equipment or similar equipment under 16 cubic yards; Mixer Trucks under 7 yards; Ready-mix Plant Hopper Operator, and Winch Trucks, 2 Axles.

Class 3. Five axle trucks; Dump Crets and Adgetors 7 yards and over; Dumpsters, Track Trucks, Euclids, Hug Bottom Dump Turntrailers or turnapulls when pulling other than self-loading equipment or similar equipment over 16 cubic yards; Explosives and/or Fission Material Trucks; Mixer Trucks 7 yards or over; Mobile Cranes while in transit; Oil Distributors, 1-man operation; Pole Trailer, over 40 feet; Pole and Expandable Trailers hauling material over 50 feet long; Slurry trucks, 1-man operation; Winch trucks, 3 axles or more; Mechanic--Truck Welder and Truck Painter.

Class 4. Six axle trucks; Dual-purpose vehicles, such as mounted crane trucks with hoist and accessories; Foreman; Master Mechanic; Self-loading equipment like P.B. and trucks with scoops on the front.

Other Classifications of Work:

For definitions of classifications not otherwise set out, the Department generally has on file such definitions which are available. If a task to be performed is not subject to one of the classifications of pay set out, the Department will upon being contacted state which neighboring county has such a classification and provide such rate, such rate being deemed to exist by reference in this document. If no neighboring county rate applies to the task, the Department shall undertake a special determination, such special determination being then deemed to have existed under this determination. If a project requires these, or any classification not listed, please contact IDOL at 217-782-1710 for wage rates or clarifications.

LANDSCAPING

Landscaping work falls under the existing classifications for laborer, operating engineer and truck driver. The work performed by landscape plantsman and landscape laborer is covered by the existing classification of laborer. The work performed by landscape operators (regardless of equipment used or its size) is covered by the classifications of operating engineer. The work performed by landscape truck drivers (regardless of size of truck driven) is covered by the classifications of truck driver.

MATERIAL TESTER & MATERIAL TESTER/INSPECTOR I AND II

Notwithstanding the difference in the classification title, the classification entitled "Material Tester I" involves the same job duties as the classification entitled "Material Tester/Inspector I". Likewise, the classification entitled "Material Tester II" involves the same job duties as the classification entitled "Material Tester/Inspector II".

Registering for DemandStar



We are pleased to announce our membership in the DemandStar network. DemandStar is an online marketplace that connects our suppliers directly to the bids, quotes and RFPs that matter to them.

DemandStar is open and accessible to all businesses and provides instant access to our solicitations. By registering for your complimentary DemandStar account, you will receive:

- **Instant** access to bids, quotes and RFPs
- **Automatic** notifications, right to you inbox, of bids that match the commodity codes you select
- The ability to **quickly view** the contractual terms and scope of work
- All the **forms and documents** you need in one place
- Access to **more government bids** in neighboring cities, counties and states

It's EASY! Get started with these 3 easy steps!

1 REGISTER

Go to:

<https://www.demandstar.com/registration>

Create an Account with DemandStar

You are one step away from picking your free government agency

Email Address

Company Name

I accept the DemandStar [Terms of Use](#) and [Privacy Policy](#)

Next



2 CHOOSE YOUR FREE AGENCY

Type in the name of the government agency you'd like to add, for example "City of Metropolis" in the Search Box

3 CHECK OUT

Check out with your **FREE AGENCY** Registration by clicking "Skip for now" on the page where it gives you options to add additional counties and States

← Choose Your Free Agency

Receive full access to the government agency of your choice and receive advance notifications of new opportunities.

City of Metropolis ✕

Narrow down your search by selecting a state and county.

State	County
Select State ▼	Select County ▼

- City of Metropolis – Board of Commisioners
- City of Metropolis Purchasing
- Metropolis Technical College

You have chosen **Metropolis Technical College** as your free agency.
Add additional government agencies below for \$25 per County,
Statewide and National subscriptions available.

My Subscriptions  [0]

Nation (0)

States (0)

Counties (0)

		Your Current Rate
Total	(0 subscriptions)	\$0/year

Proceed to Checkout

Skip for Now

SIGN UP

Visit www.demandstar.com





DEMANDSTAR

B u i l d i n g C o m m u n i t i e s .

(E-bidding) Electronic Bidding Instructions

Introduction

To submit a bid electronically (e-bidding) on DemandStar

- The project **MUST** be setup for e-bidding by the government agency advertising the opportunity

Bid Identifier	Agency Name	Bid Status	Broadcast Date	Date Due ▼	Name	Actions
RFP-2019-01-0-2019/df	Town of Malabar	Active	5/15/2019	5/31/2019	Malabar Parks and Recreation Board Memorial Wall Project	Planholders, Download/Order, Details
EBID-20190077-0-2019/HF	City of Port St. Lucie, Procurement Management Department	Active	4/25/2019	5/31/2019	Purchase Breaching "Backpack" Gas Masks and Gas Mask Cartridges for the Police Department JAG Grant Funded	E-Bidding, Planholders, Download/Order, Details



How to check if it is an e-bidding opportunity

- Not all opportunities posted on DemandStar by government are available for e-bidding
- Those that are available for you to electronically bid will list "e-bidding" as an available "ACTION" when you look at the project details

In order to do
e-bidding

1. Click on “E-bidding” in
the actions column

Bid Identifier	Agency Name	Bid Status	Broadcast Date	Date Due ▼	Name	Actions
RFP-2019-01-0-2019/df	Town of Malabar	Active	5/15/2019	5/31/2019	Malabar Parks and Recreation Board Memorial Wall Project	Planholders, Download/Order, Details
EBID-20190077-0-2019/HF	City of Port St. Lucie, Procurement Management Department	Active	4/25/2019	5/31/2019	Purchase Breaching “Backpa Gas Masks and Gas Mask Cartridges for the Police Department JAG Grant Funded	E-Bidding, Planholders, Download/Order, Details



In order to do
e-bidding

2. Enter your contact information and enter in all required fields

Note: You **MUST** put a number of the “BID AMOUNT” box. However, that number can be 0 so as to allow for a more detailed description of your bid through your uploaded documents.

Contact Information

**indicates required fields*

Company Name *

Address 1 *

Address 2

City *

State *

Postal Code *

Phone *

Fax

Country *

 Bid Amount *

Alternate Bid Amount

Notes

In order to do e-bidding

- In the agency required documents section – check the documents you intend on uploading and fulfilling. By checking these boxes this is **ONLY** an acknowledgement of how you will fulfill the requirement. You still have to upload the documents.

Required Documents



The following documents are required by the agency for this project. Please select which documents you will be submitting electronically (online) and which ones you will submit directly to the agency (offline).

Agency Required Documents

Document	None	Online/ Electronic	Offline/ Manual	Not submitting
-				
<u>Bid Reply</u>	<input type="radio"/>	<input checked="" type="radio"/>	<input type="radio"/>	<input type="radio"/>
<u>Checklist</u>	<input type="radio"/>	<input checked="" type="radio"/>	<input type="radio"/>	<input type="radio"/>
<u>Subcontractor List</u>	<input type="radio"/>	<input checked="" type="radio"/>	<input type="radio"/>	<input type="radio"/>
<u>Current Workload, List of Projects and Completion Dates</u>	<input type="radio"/>	<input checked="" type="radio"/>	<input type="radio"/>	<input type="radio"/>
<u>Questionnaire</u>	<input checked="" type="radio"/>	<input type="radio"/>	<input type="radio"/>	<input type="radio"/>
<u>Drug Free Workplace Form</u>	<input checked="" type="radio"/>	<input type="radio"/>	<input type="radio"/>	<input type="radio"/>

In order to do e-bidding

Upload your response documents in an accepted file format

Make sure that you have covered and uploaded all the required documents

E-Bid Response Documents

Agency Name	City of Port St. Lucie, Procurement Management Department
Bid Number	EBID-20190077-0-2019/HF
Bid Name	Purchase Breaching "Backpack" Kits, Gas Masks and Gas Mask Cartridges for the Police Department JAG Grant Funded
Bid Due Date	5/31/2019 3:00:00 PM Eastern time
Bid Opening	14 days, 21 hours, 45 minutes, 5 seconds

No response documents uploaded

Agency Accepted File Formats



Formats

Adobe Acrobat (*.PDF)
Microsoft Excel (*.XLS)
Microsoft Excel (*.XLSX)
Microsoft PowerPoint (*.PPT)
Microsoft Word (*.DOC)
Microsoft Word (*.DOCX)

Upload Electronic Documents

** indicates required fields*



Document Title *

Specify Upload Document *

No file chosen

(Type the path of the document, or click the Browse button.)

In order to do e-bidding

Once you decide you've uploaded all your documents that you would like to submit, make sure you click the **NEXT** button at the bottom of the screen

E-Bid Response Documents

Agency Name City of Port St. Lucie, Procurement Management Department
Bid Number EBID-20180218-0-2018/jer
Bid Name Sculpture on Lawn at City Hall Temporary Art Installation
Bid Due Date 1/9/2019 2:00:00 PM Eastern time
Bid Opening 100 days, 1 hour, 20 minutes, 11 seconds

	Document Title	Format	Size	Uploaded	Status	Action
1	 E-Bidding for Suppliers	Microsoft Word	12 Kb	10/1/2018 9:39:50 AM	Complete	View , Remove

Agency Accepted File Formats

Formats
Adobe Acrobat (*.PDF)
Microsoft Excel (*.XLS)
Microsoft Excel (*.XLSX)
Microsoft PowerPoint (*.PPT)
Microsoft Word (*.DOC)
Microsoft Word (*.DOCX)

Upload Electronic Documents

* indicates required fields

Document Title *

Specify Upload Document *

(Type the path of the document, or click the Browse button.)

Your document has successfully uploaded but your response is not yet complete. You must still click 'Submit Response' on Bid Response Details page in order to complete your response and receive a confirmation

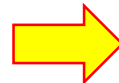

Completing your e-bid submittal

- Please **VERIFY** that you have attached **ALL** the required documents
- Click on the **Submit Response** button to complete your e-bid

Agency Required Documents

EDIT

1. **Bid Reply** (Electronic/Online) ✓
2. **Checklist** (Electronic/Online) ✓
3. **Subcontractor List** (Electronic/Online) ✓
4. **Current Workload, List of Projects and Completion Dates** (Electronic/Online) ✓
5. **Questionnaire** (Electronic/Online) ✓
6. **Drug Free Workplace Form** (Electronic/Online) ✓
7. **Current Certificate of Insurance** (Electronic/Online) ✓
8. **License/Certification to do Described Work** (Electronic/Online) ✓
9. **Reference Check Form** (Electronic/Online) ✓
10. **E-Bid Reply Excel Spreadsheet** (Electronic/Online) ✓
11. **E-Bid Bond** (Electronic/Online) ✓
12. **Vendor Code of Ethics** (Electronic/Online) ✓
13. **W-9 form** (Electronic/Online) ✓

Uploaded Documents

EDIT

1. test document upload to ensure e-bidding active

E-Bid Confirmation

After clicking "Submit Response" the following process will begin:

- We will verify that your response is complete as entered.
- You will see a confirmation page with your confirmation number and date/time stamp of your upload.
- You will receive a confirmation e-mail indicating a successful response submittal.
- You may track your response submission under the View Responses page.

If you do not receive any of the above, please call Supplier Services at (206) 940-0305.

<< Return

Submit Response

Confirmation of Response

- When you complete you will receive a confirmation
- This is a confirmation that what you uploaded will be visible to the agency when the bid closes, **this is not** a confirmation that all your documents were fill out or submitted correctly

E-Bid Response Details

Agency Name City of Port St. Lucie, Procurement Management Department

Bid Number EBID-20180218-0-2018/er

Bid Name **Sculpture on Lawn at City Hall Temporary Art Installation**

Bid Due Date 1/9/2019 2:00:00 PM Eastern time

Bid Opening 100 days, 1 hour, 6 minutes, 46 seconds

Response # 15104

Results Your bid response is submitted.

<< Return

Post Submission Edits

If you feel like you missed something or need to make a change you can go back to your submittal response and edit your e-bid. By clicking on “DETAILS” then “EDIT” the section you wish

Bid Identifier	Agency Name	Bid Status	Broadcast	Date Due ▼	Name	Status	Actions
EBID-20190077-0-2019/HF	City of Port St. Lucie, Procurement Management Department	Active	4/25/2019	5/31/2019	Purchase Breaching “Backpack” Kits, Gas Masks and Gas Mask Cartridges for the Police Department JAG Grant Funded	Incomplete	Details, Bid, History

Contact Information

EDIT

Company Name Sample DBE Company

Address 1 509 Olive Way

Address 2

City Seattle

State Washington

Postal Code 98101

Phone 2063739233

Fax 2063739233

Country United States of America

Bid Amount \$0.00

Alternate Bid Amount

Notes



Agency Required Documents

EDIT

1. Bid Reply (Electronic/Online) ✓



DemandStar E-Bidding: Frequently Asked Questions

- Do suppliers need to be registered with DemandStar to participate in e-bidding?
Yes. But if they don't already have an account with DemandStar, they can sign up and either
 - Be a subscriber for only your agency, at no charge, and be able to download documents at no charge and then receive notifications that match their commodity codes
 - Be a "basic supplier" for free - who researches on our platform and then pays \$5 to download all documents, thus becoming a plan holder
 - Be a paid subscriber for a county, state, national and receive notifications from all included agencies
- Can suppliers respond with document uploads or do they simply fill in forms?
Yes, they may respond with document uploads that are available to you via the DemandStar platform.
- What type of E-Bidding Documents can be uploaded?
Acceptable file formats for sending back documents that the city will accept:

E-Bidding Documents

Document Types	Bidding Documents - Exhibits Pricing Bid Bond
File Formats	Adobe Acrobat (*.PDF) Microsoft Excel (*.XLS) Microsoft Excel (*.XLSX) Microsoft PowerPoint (*.PPTX) Microsoft PowerPoint (*.PPT) ZIP Compressed Archive (*.ZIP)

- Is there a maximum file size that I can upload?
Vendors can simply upload a single file or multiple documents as long as it doesn't exceed 100 MBs (single or multiple files)
- After a bid opening, what document(s) are made public by DemandStar?
None. Only the agency can see the vendor responses so you are the only ones who will determine what you want to download and make public.
- Who do I call if I have questions or problems with the DemandStar?
The City strongly encourages each respondent to setup their account and to explore the eBidding module at least a couple of days before the bid due date.

If you have questions or issues creating your account, accessing the eBidding module or submitting your bid prior to the bid due date, please contact DemandStar at 866.273.1863 or by email at hello@demandstar.com.
